

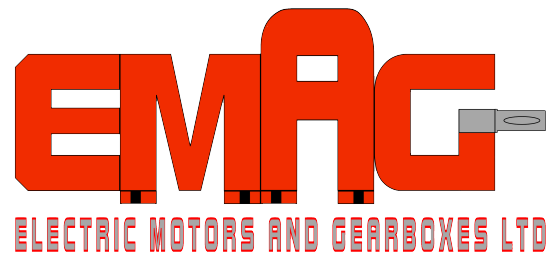

Member of **Sumitomo Drive Technologies**



OPTIDRIVE™

AC Variable Speed Drive

IP66 (NEMA 4X)

0.37kW – 22kW / 0.5HP – 30HP
110 – 480V Single and 3 Phase Input

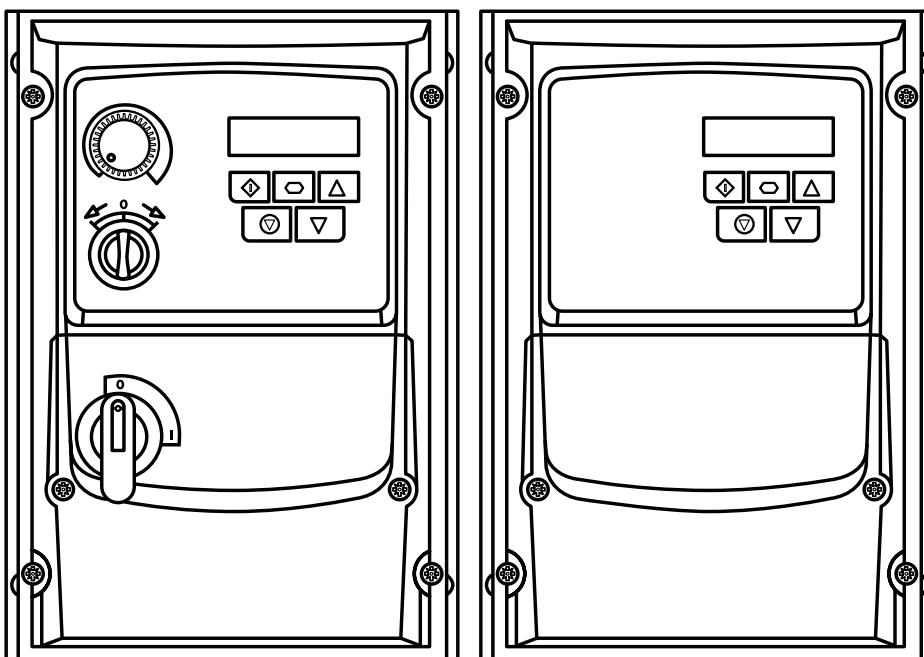

Safety Warnings	1
General Information and Ratings	2
Mechanical Installation	3
Power & Control Wiring	4
Operation	5
Parameters	6
Analog and Digital Input Macro Configurations	7
Modbus RTU Communications	8
CAN Communication	9
Technical Data	10
Troubleshooting	11

1. Safety Warnings	4	6. Parameters	23
1.1. Important Safety Information.	4	6.1. Standard Parameters.	23
2. General Information and Ratings	5	6.2. Parameter List.	23
2.1. Identifying the Drive by Model Number.	5	6.3. Parameter Functions	25
2.2. IP66 Drive Variants	5	6.4. Commissioning Various Motor Types	36
2.3. Understanding the Rating Label.....	5	6.5. P-00 Read Only Status Parameters.....	39
2.4. Drive Model Numbers.....	6	7. Analog and Digital Input Macro Configurations. .	40
3. Mechanical Installation	7	7.1. Overview	40
3.1. General	7	7.2. Example Connection Diagrams.....	40
3.2. UL Compliant Installation	7	7.3. Macro Functions Guide Key	41
3.3. Mechanical Dimensions – IP66 (Nema 4X) Enclosed Units ...	7	7.4. Macro Functions – Terminal Mode (P-12 = 0).....	42
3.4. Guidelines for mounting (IP66 Units)	8	7.5. Macro Functions - Keypad Mode (P-12 = 1 or 2)	43
3.5. Gland Plate and Lock Off	8	7.6. Macro Functions - Fieldbus Control Mode (P-12 = 3, 4, 7, 8 or 9).....	43
3.6. Removing the Terminal Cover	9	7.7. Macro Functions - User PI Control Mode (P-12 = 5 or 6) ...	44
3.7. Routine Maintenance	9	8. Modbus RTU Communications	45
4. Power & Control Wiring	10	8.1. Introduction.	45
4.1. Connection Locations	10	8.2. Modbus RTU Specification	45
4.2. Connection Diagram	11	8.3. RJ45 Connector Configuration	45
4.3. Protective Earth (PE) Connection.....	12	8.4. Modbus Register Map.....	46
4.4. Incoming Power Connection	13	9. CAN Communication	48
4.5. Motor Connection	14	9.1. CAN Communication	48
4.6. Motor Terminal Box Connections	14	9.2. Additional Information Relating to CAN or Modbus or Both	51
4.7. Control Terminal Wiring	14	10. Technical Data	52
4.8. Using the REV/0/FWD Selector Switch (Versions With Local Controls Only).....	15	10.1. Environmental.....	52
4.9. Using the Internal Pot (Local Control Versions Only)	16	10.2. Rating Tables.....	52
4.10. Control Terminal Connections	16	10.3. Single Phase Operation of Three Phase Drives	52
4.11. Motor Thermal Overload Protection	18	10.4. Additional Information for UL Compliance.....	53
4.12. EMC Compliant Installation	18	10.5. EMC Filter Disconnect	53
4.13. Optional Brake Resistor.....	18	11. Troubleshooting	54
5. Operation	20	11.1. Fault Code Messages	54
5.1. Managing the Keypad	20	12. Energy Efficiency Classification	56
5.2. Operating Displays.....	20		
5.3. Changing Parameters.....	20		
5.4. Read Only Parameter Access	21		
5.5. Resetting Parameters.....	21		
5.6. Resetting a Fault.....	21		
5.7. LED Display	22		

Intended Audience

This User Manual is intended to be used in conjunction with the Quick Start User Guide included with the product, and is intended to provide additional information for more advanced product applications and usage. The reader should be familiar with the contents of the Quick Start User Guide, and in particular, should observe all safety warnings and installation guidelines contained therein.

Declaration of Conformity

Invertek Drives Ltd hereby states that the Optidrive ODE-3 product range conforms to the relevant safety provisions of the following council directives:

2014/30/EU (EMC) and 2014/35/EU (LVD)

Designed and manufacture is in accordance with the following harmonised European standards:

EN 61800-5-1: 2007	Adjustable speed electrical power drive systems. Safety requirements. Electrical, thermal and energy.
EN 61800-3: 2004 /A1 2012	Adjustable speed electrical power drive systems. EMC requirements and specific test methods
EN 55011: 2007	Limits and Methods of measurement of radio disturbance characteristics of industrial, scientific and medical (ISM) radio-frequency equipment (EMC)
EN60529: 1992	Specifications for degrees of protection provided by enclosures

Electromagnetic Compatibility

All Optidrives are designed with high standards of EMC in mind. All versions suitable for operation on Single Phase 230 volt and Three Phase 400 volt supplies and intended for use within the European Union are fitted with an internal EMC filter. This EMC filter is designed to reduce the conducted emissions back into the mains supply via the power cables for compliance with the above harmonised European standards.

It is the responsibility of the installer to ensure that the equipment or system into which the product is incorporated complies with the EMC legislation of the country of use, and the relevant category. Within the European Union, equipment into which this product is incorporated must comply with the EMC Directive 2004/108/EC. This User Guide provides guidance to ensure that the applicable standards may be achieved.

Copyright Invertek Drives Ltd © 2021

All rights reserved. No part of this User Guide may be reproduced or transmitted in any form or by any means, electrical or mechanical including photocopying, recording or by any information storage or retrieval system without permission in writing from the publisher.

2 Year Warranty

All Invertek Optidrive units carry a 2 year warranty against manufacturing defects from the date of manufacture. The manufacturer accepts no liability for any damage caused during or resulting from transport, receipt of delivery, installation or commissioning. The manufacturer also accepts no liability for damage or consequences resulting from inappropriate, negligent or incorrect installation, incorrect adjustment of the operating parameters of the drive, incorrect matching of the drive to the motor, incorrect installation, unacceptable dust, moisture, corrosive substances, excessive vibration or ambient temperatures outside of the design specification.

The local distributor may offer different terms and conditions at their discretion, and in all cases concerning warranty, the local distributor should be contacted first.





This user guide is the “original instructions” document. All non-English versions are translations of the “original instructions”.

The contents of this User Guide are believed to be correct at the time of printing. In the interest of a commitment to a policy of continuous improvement, the manufacturer reserves the right to change the specification of the product or its performance or the contents of the User Guide without notice.

This User Guide is for use with version 3.09 Firmware

User Guide Revision 1.23

Invertek Drives Ltd adopts a policy of continuous improvement and whilst every effort has been made to provide accurate and up to date information, the information contained in this User Guide should be used for guidance purposes only and does not form the part of any contract.

	When installing the drive on any power supply where the phase-ground voltage may exceed the phase-phase voltage (typically IT supply networks or Marine vessels) it is essential that the internal EMC filter ground and surge protection varistor ground (where fitted) are disconnected. If in doubt, refer to your Sales Partner for further information.
	This manual is intended as a guide for proper installation. Invertek Drives Ltd cannot assume responsibility for the compliance or the non-compliance to any code, national, local or otherwise, for the proper installation of this drive or associated equipment. A hazard of personal injury and/or equipment damage exists if codes are ignored during installation.
	This Optidrive contains high voltage capacitors that take time to discharge after removal of the main supply. Before working on the drive, ensure isolation of the main supply from line inputs. Wait ten (10) minutes for the capacitors to discharge to safe voltage levels. Failure to observe this precaution could result in severe bodily injury or loss of life.
	Only qualified electrical personnel familiar with the construction and operation of this equipment and the hazards involved should install, adjust, operate, or service this equipment. Read and understand this manual and other applicable manuals in their entirety before proceeding. Failure to observe this precaution could result in severe bodily injury or loss of life.

1. Safety Warnings

1.1. Important Safety Information

Please read the IMPORTANT SAFETY INFORMATION below, and all Warning and Caution information elsewhere.



Danger: Indicates a risk of electric shock, which, if not avoided, could result in damage to the equipment and possible injury or death.

This variable speed drive product (Optidrive) is intended for professional incorporation into complete equipment or systems as part of a fixed installation. If installed incorrectly it may present a safety hazard. The Optidrive uses high voltages and currents, carries a high level of stored electrical energy, and is used to control mechanical plant that may cause injury. Close attention is required to system design and electrical installation to avoid hazards in either normal operation or in the event of equipment malfunction. Only qualified electricians are allowed to install and maintain this product.

System design, installation, commissioning and maintenance must be carried out only by personnel who have the necessary training and experience. They must carefully read this safety information and the instructions in this Guide and follow all information regarding transport, storage, installation and use of the Optidrive, including the specified environmental limitations.

Do not perform any flash test or voltage withstand test on the Optidrive. Any electrical measurements required should be carried out with the Optidrive disconnected.

Electric shock hazard! Disconnect and ISOLATE the Optidrive before attempting any work on it. High voltages are present at the terminals and within the drive for up to 10 minutes after disconnection of the electrical supply. Always ensure by using a suitable multimeter that no voltage is present on any drive power terminals prior to commencing any work.

Where supply to the drive is through a plug and socket connector, do not disconnect until 10 minutes have elapsed after turning off the supply.

Ensure correct earthing connections. The earth cable must be sufficient to carry the maximum supply fault current which normally will be limited by the fuses or MCB. Suitably rated fuses or MCB should be fitted in the mains supply to the drive, according to any local legislation or codes.

Ensure correct earthing connections and cable selection as per defined by local legislation or codes. The drive may have a leakage current of greater than 3.5mA; furthermore the earth cable must be sufficient to carry the maximum supply fault current which normally will be limited by the fuses or MCB. Suitably rated fuses or MCB should be fitted in the mains supply to the drive, according to any local legislation or codes.

Do not carry out any work on the drive control cables whilst power is applied to the drive or to the external control circuits.



Danger: Indicates a potentially hazardous situation other than electrical, which if not avoided, could result in damage to property.

Within the European Union, all machinery in which this product is used must comply with Directive 2006/42/EC, Safety of Machinery. In particular, the machine manufacturer is responsible for providing a main switch and ensuring the electrical equipment complies with EN60204-1.

The level of integrity offered by the Optidrive control input functions – for example stop/start, forward/reverse and maximum speed is not sufficient for use in safety-critical applications without independent channels of protection. All applications where malfunction could cause injury or loss of life must be subject to a risk assessment and further protection provided where needed.

The driven motor can start at power up if the enable input signal is present.

The STOP function does not remove potentially lethal high voltages. ISOLATE the drive and wait 10 minutes before starting any work on it. Never carry out any work on the Drive, Motor or Motor cable whilst the input power is still applied.

The Optidrive can be programmed to operate the driven motor at speeds above or below the speed achieved when connecting the motor directly to the mains supply. Obtain confirmation from the manufacturers of the motor and the driven machine about suitability for operation over the intended speed range prior to machine start up.

Do not activate the automatic fault reset function on any systems whereby this may cause a potentially dangerous situation.

When mounting the drive, ensure that sufficient cooling is provided. Do not carry out drilling operations with the drive in place, dust and swarf from drilling may lead to damage.

The entry of conductive or flammable foreign bodies should be prevented. Flammable material should not be placed close to the drive

Relative humidity must be less than 95% (non-condensing).

Ensure that the supply voltage, frequency and no. of phases (1 or 3 phase) correspond to the rating of the Optidrive as delivered.

Never connect the mains power supply to the Output terminals U, V, W.

Do not install any type of automatic switchgear between the drive and the motor.

Wherever control cabling is close to power cabling, maintain a minimum separation of 100 mm and arrange crossings at 90 degrees. Ensure that all terminals are tightened to the appropriate torque setting.

Do not attempt to carry out any repair of the Optidrive. In the case of suspected fault or malfunction, contact your local Invertek Drives Sales Partner for further assistance.

2. General Information and Ratings

This chapter contains information about the Optidrive E3 including how to identify the drive.

2.1. Identifying the Drive by Model Number

Each drive can be identified by its model number, as shown in the table below. The model number is on the shipping label and the drive nameplate. The model number includes the drive and any options.

ODE	-	3	-	1	2	0021	-	1	F	1	A
Product Family											IP Rating A = IP66 Non Switched B = IP66 Switched C = IP66 with local controls E = IP66 with switch-disconnector
Generation									Dynamic Brake Transistor 1 = Not Fitted 4 = Internal Transistor		
Frame Size									Filter Type 0 = No Filter F = Internal EMC Filter		
Input Voltage	1 = 110 – 115 2 = 200 – 240 4 = 380 – 480										No. Of Input Phases Output Current x 10

2.2. IP66 Drive Variants

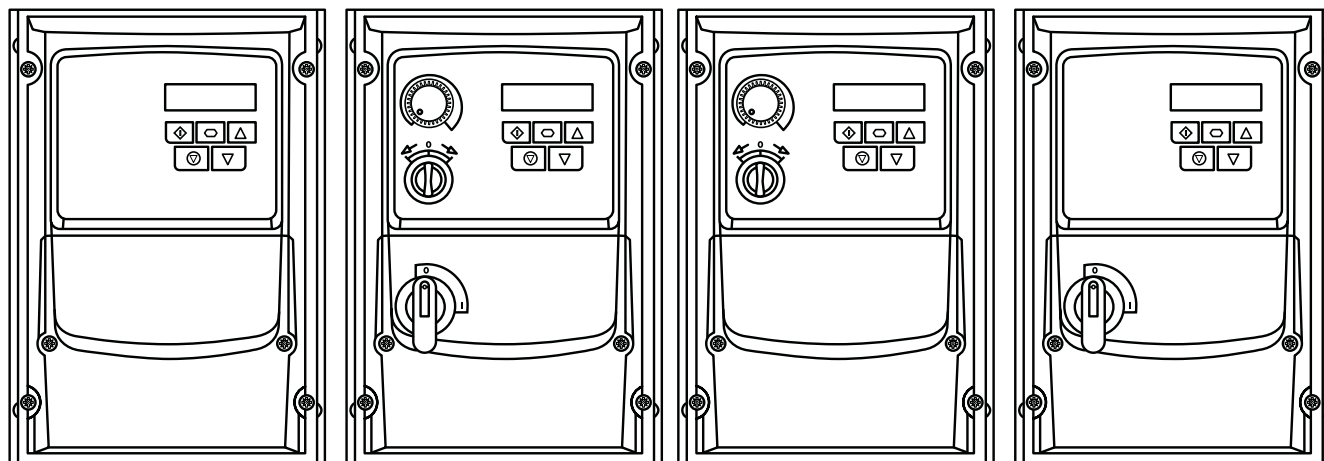

A = IP66 Non Switched

B = IP66 Switched

C = IP66 with local controls

E = IP66 with switch-disconnector

2.3. Understanding the Rating Label

The product rating label provides the following information

	Key
1	Model Code
2	Enclosure Type and IP Rating
3	Firmware Version
4	Serial Number
5	Technical Data – Supply Voltage
6	Technical Data – Maximum continuous output current

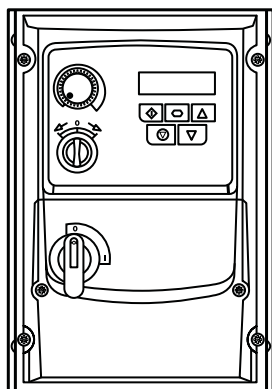

On right hand side when viewed from the front.

Inverter
Drives.com

Made in the UK
IP66 / NEW

2

1 OPTIDRIVE E3

ODE-3-120023-1F1A

	V	∅	F(Hz)	I (A)	kW	HP
Input	200-240	1	50/60	3.7	0.37	0.5
Output	0-250	3	0-500	2.3		

5

Risk of Electric Shock

Power down for 5min before removing cover

Read User Guide Before installation or servicing
SCCR: For rating and protection refer to User Guide

CAUTION

4

3

Listed 2A00
Ind.Cont.Eq.
E226333

Serial No.: 1111111111 S/Ware 3.08

www.inverterdrives.com 918070

2.4. Drive Model Numbers

110 – 115V ± 10% - 1 Phase Input – 3 Phase 230V Output (Voltage Doubler)					
Model Number		kW	HP	Output Current (A)	Frame Size
With Filter	Without Filter				
N/A	ODE-3-110023-101#		0.5	2.3	1
N/A	ODE-3-110043-101#		1	4.3	1
N/A	ODE-3-210058-104#		1.5	5.8	2

200 – 240V ± 10% - 1 Phase Input – 3 Phase Output					
Model Number		kW	HP	Output Current (A)	Frame Size
With Filter	Without Filter				
ODE-3-120023-1F1#	ODE-3-120023-101#	0.37	0.5	2.3	1
ODE-3-120043-1F1#	ODE-3-120043-101#	0.75	1	4.3	1
ODE-3-120070-1F1#	ODE-3-120070-101#	1.5	2	7	1
ODE-3-220070-1F4#	ODE-3-220070-104#	1.5	2	7	2
ODE-3-220105-1F4#	ODE-3-220105-104#	2.2	3	10.5	2
ODE-3-320153-1F4#	ODE-3-320153-104#	4.0	5	15.3	3

200 – 240V ± 10% - 3 Phase Input – 3 Phase Output					
Model Number		kW	HP	Output Current (A)	Frame Size
With Filter	Without Filter				
ODE-3-120023-3F1#	ODE-3-120023-301#	0.37	0.5	2.3	1
ODE-3-120043-3F1#	ODE-3-120043-301#	0.75	1	4.3	1
ODE-3-120070-3F1#	ODE-3-120070-301#	1.5	2	7	1
ODE-3-220070-3F4#	ODE-3-220070-304#	1.5	2	7	2
ODE-3-220105-3F4#	ODE-3-220105-304#	2.2	3	10.5	2
ODE-3-320180-3F4#	ODE-3-320180-304#	4.0	5	18	3
ODE-3-320240-3F4#	ODE-3-320240-304#	5.5	7.5	24	3
ODE-3-420300-3F4#	ODE-3-420300-304#	7.5	10	30	4
ODE-3-420460-3F4#	ODE-3-420460-304#	11	15	46	4

380 – 480V ± 10% - 3 Phase Input – 3 Phase Output					
Model Number		kW	HP	Output Current (A)	Frame Size
With Filter	Without Filter				
ODE-3-140022-3F1#	ODE-3-140022-301#	0.75	1	2.2	1
ODE-3-140041-3F1#	ODE-3-140041-301#	1.5	2	4.1	1
ODE-3-240041-3F4#	ODE-3-240041-304#	1.5	2	4.1	2
ODE-3-240058-3F4#	ODE-3-240058-304#	2.2	3	5.8	2
ODE-3-240095-3F4#	ODE-3-240095-304#	4	5	9.5	2
ODE-3-340140-3F4#	ODE-3-340140-304#	5.5	7.5	14	3
ODE-3-340180-3F4#	ODE-3-340180-304#	7.5	10	18	3
ODE-3-340240-3F4#	ODE-3-340240-3042	11	15	24	3
ODE-3-440300-3F4#	ODE-3-440300-3042	15	20	30	4
ODE-3-440390-3F4#	ODE-3-440390-3042	18.5	25	39	4
ODE-3-440460-3F4#	ODE-3-440460-3042	22	30	46	4

For IP66 replace the '#' with:

	IP66	FWD/REV	Pot	Disconnect
A	✓	x	x	x
B	✓	✓	✓	✓
C	✓	✓	✓	x
E	✓	x	x	✓

NOTE

3. Mechanical Installation

3.1. General

- The Optidrive should be mounted in a vertical position only, on a flat, flame resistant, vibration free mounting using the integral mounting holes.
- Do not mount flammable material close to the Optidrive.
- Ensure that the minimum cooling air gaps, as detailed in section 3.4. Guidelines for mounting (IP66 Units).
- Ensure that the ambient temperature range does not exceed the permissible limits for the Optidrive given in section 10.1. Environmental.

3.2. UL Compliant Installation

Refer to section 10.4. Additional Information for UL Compliance on page 53 for Additional Information for UL Compliance.

3.3. Mechanical Dimensions – IP66 (NEMA 4X) Enclosed Units

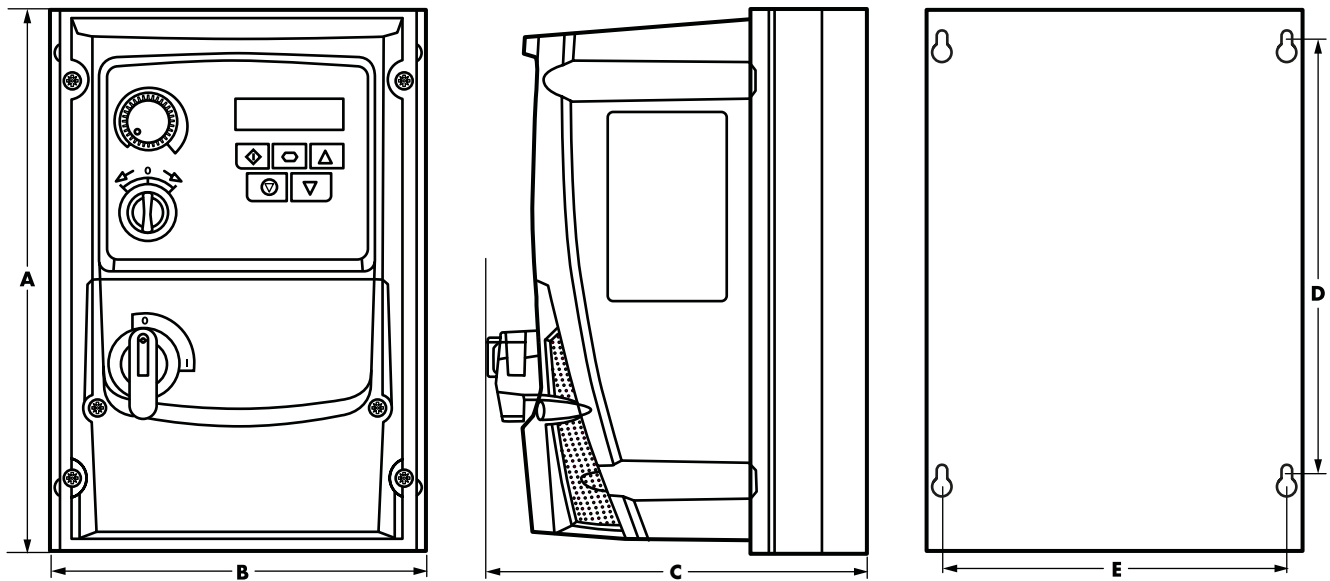

Mechanical Installation

Drive Size	A		B		C		D		E		Weight	
	mm	in	mm	in	mm	in	mm	in	mm	in	kg	lb
1	232.0	9.13	161.0	6.34	162.0	6.37	189.0	7.44	148.5	5.85	2.5	5.5
2	257.0	10.12	188.0	7.40	182.0	7.16	200.0	7.87	176.0	6.93	3.5	7.7
3	310.0	12.20	211.0	8.30	238.0	9.37	251.5	9.90	197.5	7.78	7.0	15.4
4	360.0	14.17	240.0	9.44	275.0	10.82	300.0	11.08	227.0	8.89	9.5	20.9

Mounting Bolts	
Frame Size	
All Frame Sizes	4 x M4 (#8)

Tightening Torques		
Frame Size	Control Terminals	Power Terminals
1, 2, 3	0.5 Nm (4.4 lb-in)	1.5 Nm (13 lb-in)
4	0.5 Nm (4.4 lb-in)	4.1 Nm (36.5 lb-in)

3

3.4. Guidelines for mounting (IP66 Units)

- Before mounting the drive, ensure that the chosen location meets the environmental condition requirements for the drive shown in section 10.1. Environmental.
- The drive must be mounted vertically, on a suitable flat surface.
- The minimum mounting clearances as shown in the table below must be observed.
- The mounting site and chosen mountings should be sufficient to support the weight of the drives.
- Using the drive as a template, or the dimensions shown above, mark the locations required for drilling.
- Suitable cable glands to maintain the ingress protection of the drive are required. Gland holes for power and motor cables are pre-moulded into the drive enclosure, recommended gland sizes are shown below. Gland holes for control cables may be cut as required.
- The mounting location should be free from vibration.
- Do not mount the drive in any area with excessive humidity, corrosive airborne chemicals or potentially dangerous dust particles.
- Avoid mounting close to high heat sources.
- The drive must not be mounted in direct sunlight. If necessary, install a suitable shade cover.
- The mounting location must be free from frost.
- Do not restrict the flow of air through the drive heatsink. The drive generates heat which must be naturally allowed to dissipate. Correct air clearance around the drive must be observed.
- If the location is subject to wide ambient temperature and air pressure variation, install a suitable pressure compensation valve in the drive gland plate.

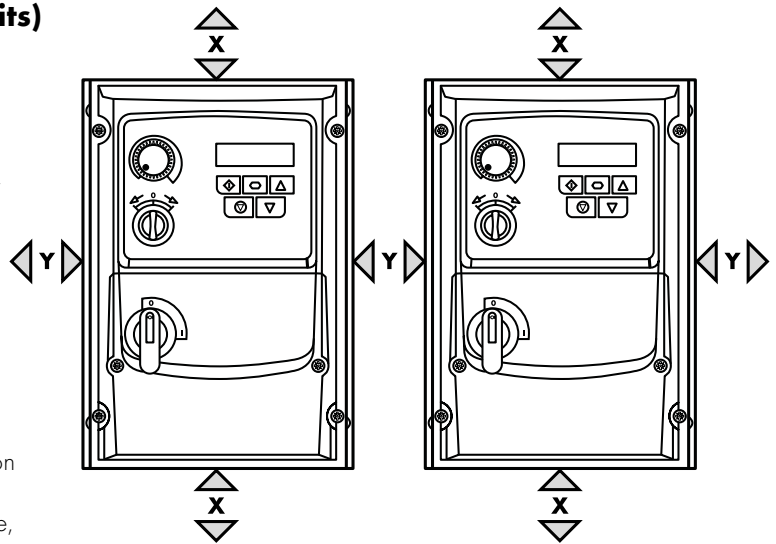

NOTE If the drive has been in storage for a period longer than 2 years, the DC link capacitors must be reformed.

Drive Size	X Above & Below		Y Either Side	
	mm	in	mm	in
1	200	7.87	10	0.39
2	200	7.87	10	0.39
3	200	7.87	10	0.39
4	200	7.87	10	0.39

NOTE Above are guidelines only and the operating ambient temperature of the drive **MUST** be maintained within the limits shown in section 10.1. Environmental at all times.

3.5. Gland Plate and Lock Off

The use of a suitable gland system is required to maintain the appropriate IP / NEMA rating. The gland plate has pre moulded cable entry holes for power and motor connections suitable for use with glands as shown in the following table. Where additional holes are required, these can be drilled to suitable size. Please take care when drilling to avoid leaving any particles within the product.

Recommended cable gland types and hole sizes

Drive Size	Power & Motor Cables		
	Hole Size	Recommended PG Gland	Alternative Metric gland
Size 1	22	PG16	M20
Size 2 & 3	27	PG21	M25
Size 4	37	PG29	-

- UL rated ingress protection ("Type") is only met when cables are installed using a UL recognized bushing or fitting for a flexible-conduit system which meets the required level of protection ("Type").
- For conduit installations the conduit entry holes require standard opening to the required sizes specified per the NEC.
- Not intended for installation using rigid conduit system.

IP66 / NEMA 4X Gland Plate

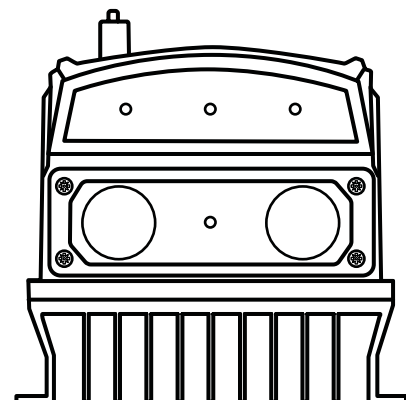

Mains switch-disconnector Lock Off

On the switched models the mains switch-disconnector can be locked in the 'Off' position using a 20mm standard shackle padlock (not supplied).

IP66 / NEMA 4X Unit Lock Off

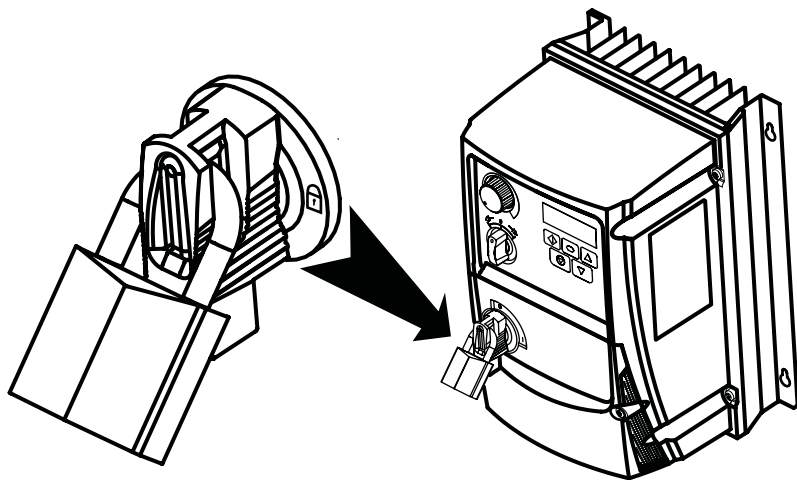

3.6. Removing the Terminal Cover

To access the connection terminals, the drive front cover needs to be removed as shown.

IP66 / NEMA 4X Units

Removing the screws on the front of the product allows access to the connection terminals, as shown below.

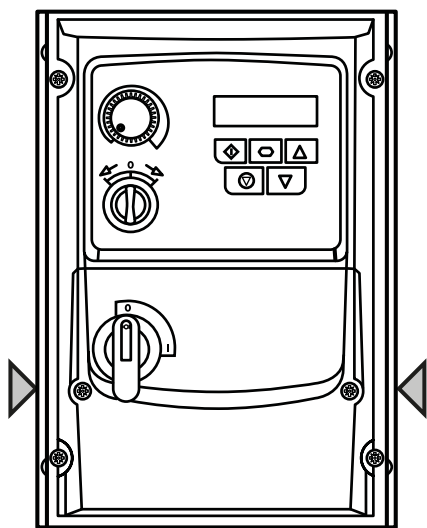

3.7. Routine Maintenance

The drive should be included within the scheduled maintenance program so that the installation maintains a suitable operating environment, this should include:

- Ambient temperature is at or below that set out in section 10.1. Environmental.
- Heat sink fans (where fitted) freely rotating and dust free.
- The Enclosure in which the drive is installed should be free from dust and condensation; furthermore ventilation fans and air filters should be checked for correct air flow.

Checks should also be made on all electrical connections, ensuring screw terminals are correctly torqued; and that power cables have no signs of heat damage.

4. Power & Control Wiring

4.1. Connection Locations

4.1.1. Connection locations – Frame size 1

Single phase supply

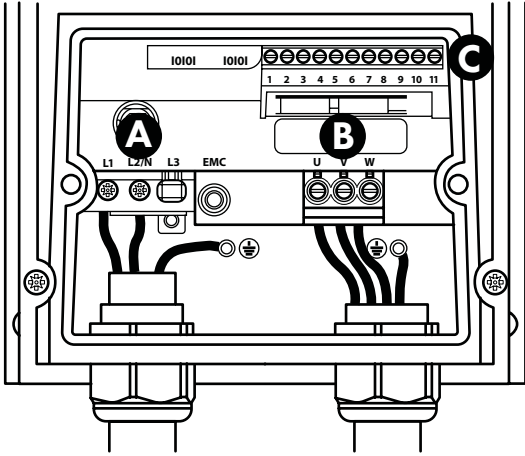

3 phase supply

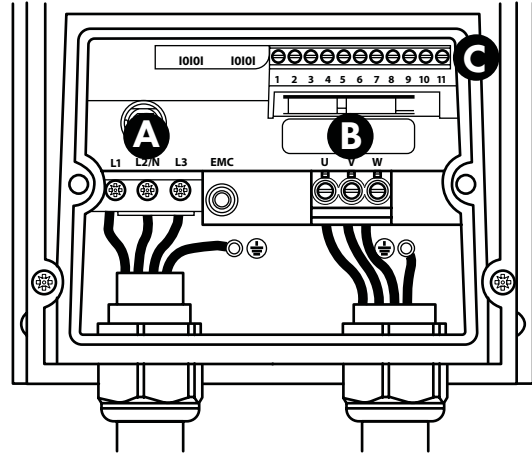

4.1.2. Connection locations – Frame sizes 2, 3 and 4

Single phase supply

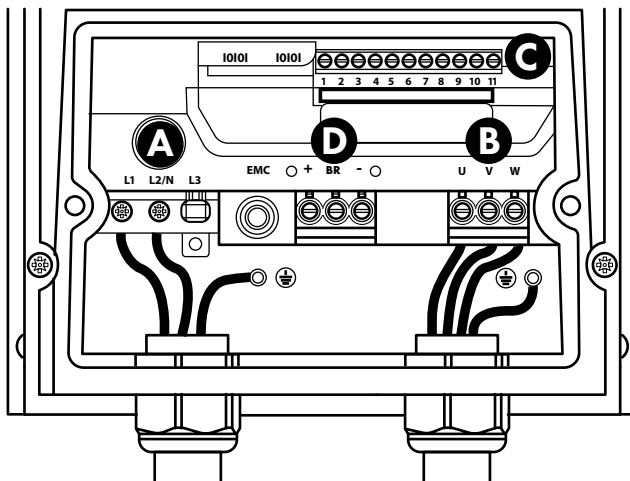

3 phase supply

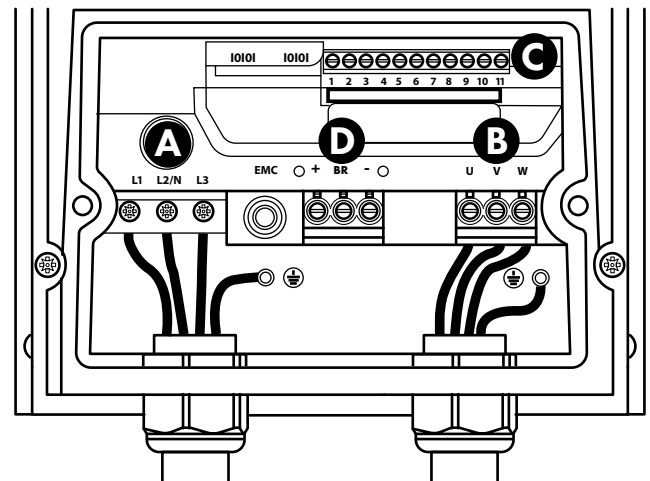

- A** – Incoming Power Connections see section 4.4. Incoming Power Connection for more information
- B** – Motor Connections see section 4.5. Motor Connection for more information
- C** – Control Terminal Connections see section 4.10. Control Terminal Connections for more information
- D** – Brake Resistor see section 4.13. Optional Brake Resistor for more information

4.2. Connection Diagram

All power terminal locations are marked directly on the product. DC+/BR/DC- terminals are not available on Size 1 models.

4.2.1. IP66 (Nema 4X) Non-Switched Units

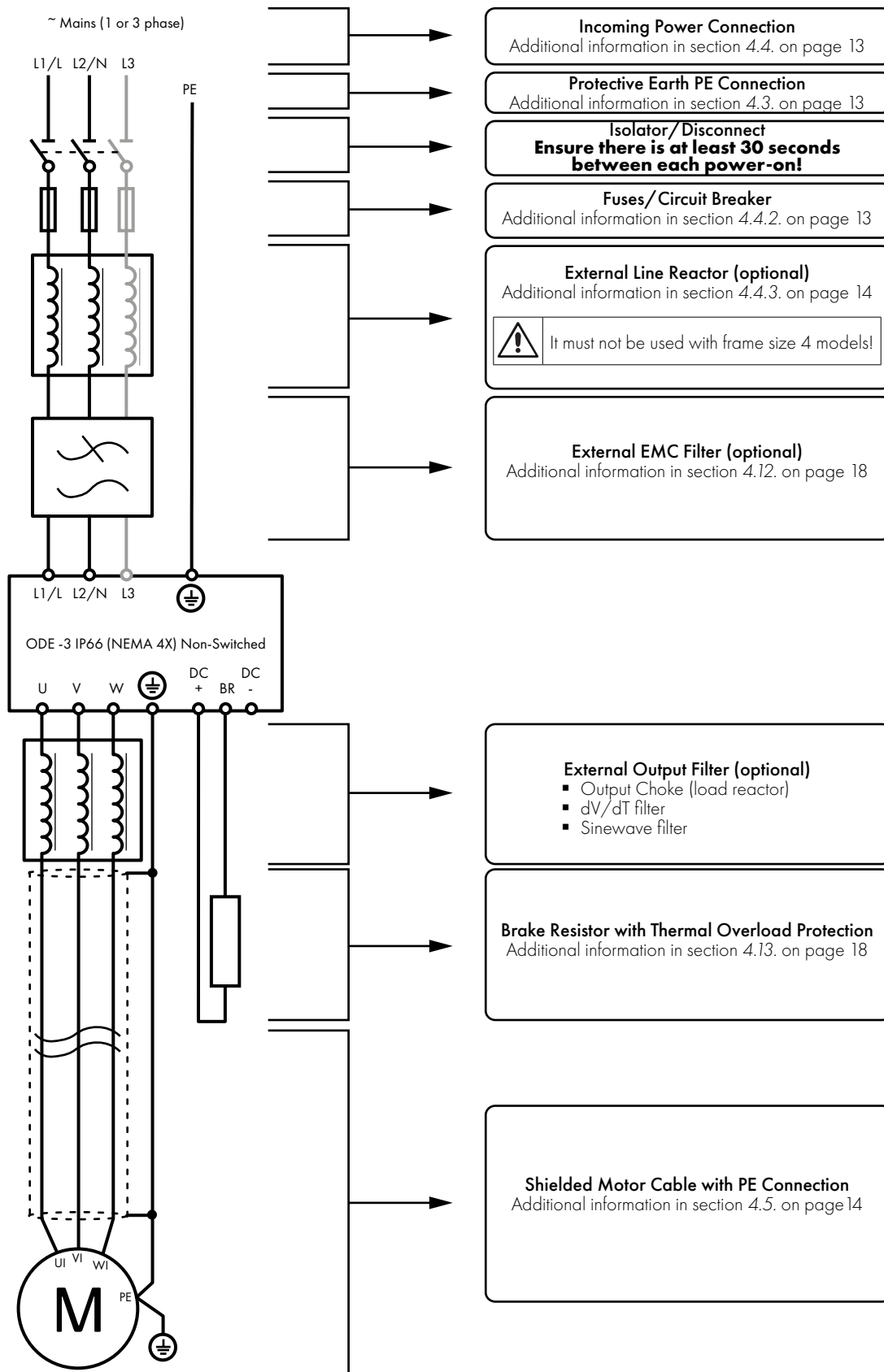

4.2.2. Electrical Power Connections – IP66 (NEMA 4X) Switched Models

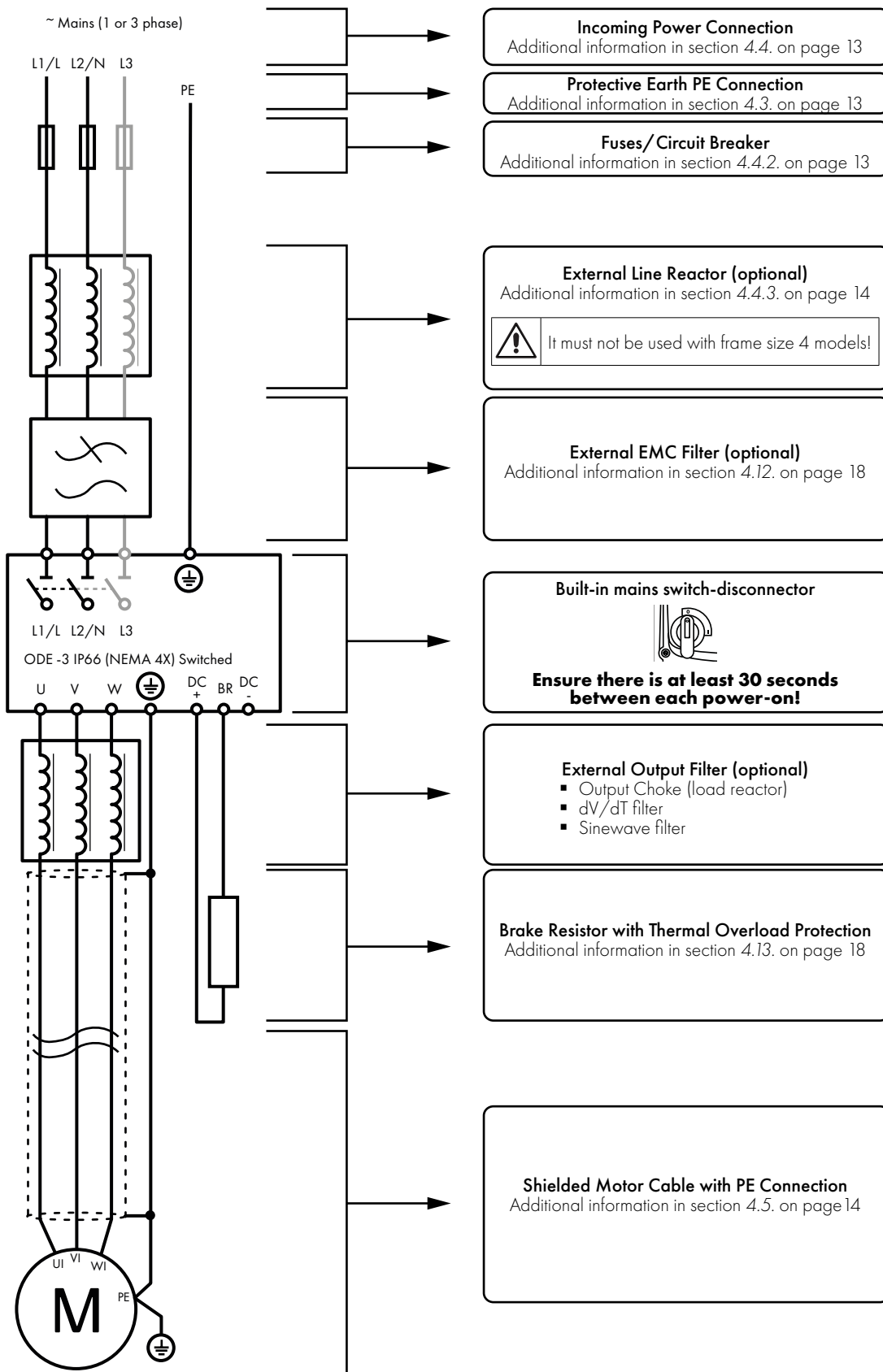

4.3. Protective Earth (PE) Connection

Grounding Guidelines

The ground terminal of each Optidrive should be individually connected DIRECTLY to the site ground bus bar (through the filter if installed). Optidrive ground connections should not loop from one drive to another, or to, or from any other equipment. Ground loop impedance must conform to local industrial safety regulations. To meet UL regulations, UL approved ring crimp terminals should be used for all ground wiring connections.

The drive Safety Ground must be connected to system ground. Ground impedance must conform to the requirements of national and local industrial safety regulations and/or electrical codes. The integrity of all ground connections should be checked periodically.

Protective Earth Conductor

The Cross sectional area of the PE Conductor must be at least equal to that of the incoming supply conductor.

Safety Ground

This is the safety ground for the drive that is required by code. One of these points must be connected to adjacent building steel (girder, joist), a floor ground rod, or bus bar. Grounding points must comply with national and local industrial safety regulations and/or electrical codes.

Motor Ground

The motor ground must be connected to one of the ground terminals on the drive.

Ground Fault Monitoring

As with all inverters, a leakage current to earth can exist. The Optidrive is designed to produce the minimum possible leakage current whilst complying with worldwide standards. The level of current is affected by motor cable length and type, the effective switching frequency, the earth connections used and the type of RFI filter installed. If an ELCB (Earth Leakage Circuit Breaker) is to be used, the following conditions apply:

- A Type B Device must be used.
- The device must be suitable for protecting equipment with a DC component in the leakage current.
- Individual ELCBs should be used for each Optidrive.

Shield Termination (Cable Screen)

The safety ground terminal provides a grounding point for the motor cable shield. The motor cable shield connected to this terminal (drive end) should also be connected to the motor frame (motor end). Use a shield terminating or EMI clamp to connect the shield to the safety ground terminal.

4.4. Incoming Power Connection

4.4.1. Cable Selection

- For 1 phase supply, the mains power cables should be connected to L1/L, L2/N.
- For 3 phase supplies, the mains power cables should be connected to L1, L2, and L3. Phase sequence is not important.
- For compliance with CE EMC requirements, refer to section 4.12. EMC Compliant Installation on page 18.
- A fixed installation is required according to IEC61800-5-1 with a suitable disconnecting device installed between the Optidrive and the AC Power Source. The disconnecting device must conform to the local safety code / regulations (e.g. within Europe, EN60204-1, Safety of machinery).
- The cables should be dimensioned according to any local codes or regulations. Maximum dimensions are given in section 10.2. Rating Tables.

4.4.2. Fuse / Circuit Breaker Selection

- Suitable fuses to provide wiring protection of the input power cable should be installed in the incoming supply line, according to the data in section 10.2. Rating Tables. The fuses must comply with any local codes or regulations in place. In general, type gG (IEC 60269) or UL type J fuses are suitable; however in some cases type aR fuses may be required. The operating time of the fuses must be below 0.5 seconds.
- Where allowed by local regulations, suitably dimensioned type B MCB circuit breakers of equivalent rating may be utilised in place of fuses, providing that the clearing capacity is sufficient for the installation.
- The maximum permissible short circuit current at the Optidrive Power terminals as defined in IEC60439-1 is 100kA.

4.4.3. Optional Input Choke

- Do not use input choke with size 4 models!
- An optional Input Choke is recommended to be installed in the supply line for drives frame size 1, 2 and 3 where any of the following conditions occur:
 - The incoming supply impedance is low or the fault level / short circuit current is high.
 - The supply is prone to dips or brown outs.
 - An imbalance exists on the supply (3 phase drives).
 - The power supply to the drive is via a busbar and brush gear system (typically overhead Cranes).
- In all other installations, an input choke is recommended to ensure protection of the drive against power supply faults. Part numbers are shown in the table.

Supply	Frame Size	AC Input Inductor
230 Volt 1 Phase	1	OPT-2-L1016-66
	2	OPT-2-L1025-66
400 Volt 3 Phase	1	OPT-2-L3006-66
	2	OPT-2-L3010-66
	3	OPT-2-L3018-66

4.5. Motor Connection

- The drive inherently produces fast switching of the output voltage (PWM) to the motor compared to the mains supply. For motors which have been wound for operation with a variable speed drive additional measures are not required; however if the quality of insulation is unknown the motor manufacturer should be consulted and preventative measures may be required.
- The motor should be connected to the Optidrive U, V, and W terminals using a suitable 3 or 4 core cable. Where a 3 core cable is utilised, with the shield operating as an earth conductor, the shield must have a cross sectional area at least equal to the phase conductors when they are made from the same material. Where a 4 core cable is utilised, the earth conductor must be of at least equal cross sectional area and manufactured from the same material as the phase conductors.
- The motor earth must be connected to one of the Optidrive earth terminals.
- Maximum permitted motor cable length for all models: 100 metres shielded, 150 metres unshielded.
- Where multiple motors are connected to a single drive using parallel cables, an output choke **must** be installed.

4.6. Motor Terminal Box Connections

Do not install any mechanical or electro-mechanical switching devices between the drive and motor. Where a local isolator is installed close to the motor, this should be interlocked with the drive control circuit to ensure the drive is disabled when the motor is isolated. Most general purpose motors are wound for operation on dual voltage supplies. This is indicated on the nameplate of the motor. This operational voltage is normally selected when installing the motor by selecting either STAR or DELTA connection. STAR always gives the higher of the two voltage ratings.

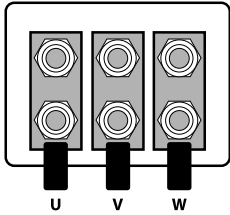
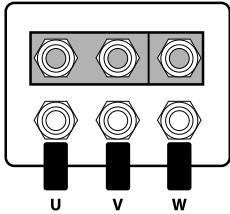
Incoming Supply Voltage	Motor Nameplate Voltages	Connection	
230	230 / 400	Delta Δ	
400	400 / 690		
400	230 / 400	Star λ	





4.7. Control Terminal Wiring

- All analog signal cables should be suitably shielded. Twisted pair cables are recommended.
- Power and Control Signal cables should be routed separately where possible, and must not be routed parallel to each other.
- Signal levels of different voltages e.g. 24 Volt DC and 110 Volt AC, should not be routed in the same cable.
- Maximum control terminal tightening torque is 0.5Nm.
- Control Cable entry conductor size: 0.05 – 2.5mm² / 30 – 12 AWG.











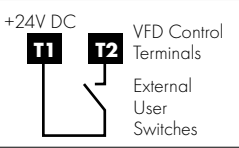

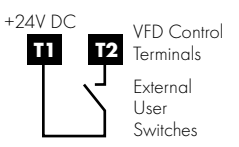

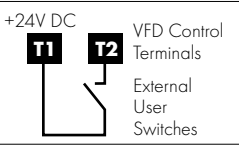

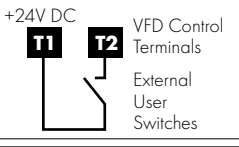

4.8. Using the REV/O/FWD Selector Switch (Versions With Local Controls Only)

By adjusting the parameter settings the Optidrive can be configured for multiple applications and not just for Forward or Reverse. This could typically be for Hand/Off/Auto applications (also known as Local/Remote) for HVAC and pumping industries. The integrated switch operates in parallel with drive terminal 2 (T2) and terminal 3 (T3) as digital input 1 and digital input 2. By default, the integrated switch is enabled.

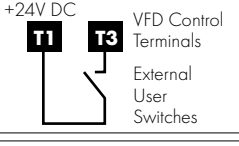
4.8.1. Default functions of the control switches

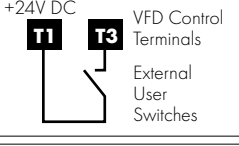
Switch Position			POT	Notes
 Run Reverse	 STOP	 Run Forward	 Sets the output frequency	Factory Default Configuration. Run Forward or Reverse with speed controlled from the Local POT.

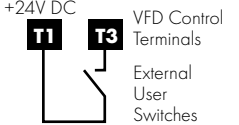
4.8.2. Switch Configuration

P-64 = 0	DI1 = T2 OR Switch REV OR Switch FWD		OR	 Run Reverse	OR	 Run Forward
P-64 = 1	DI1 = T2 only			 Run Reverse		 Run Forward
P-64 = 2	DI1 = T2 OR Switch FWD		OR	 Run Forward		
P-64 = 3	DI1 = T2 AND Switch FWD OR T2 AND Switch REV	OR		 Run Forward	AND	 Run Reverse
				 Run Reverse	AND	 Run Forward
P-64 = 4	DI1 = T2 AND Switch FWD		AND	 Run Forward		
P-65 = 0	DI2 = T3 OR Switch REV		OR	 Run Reverse		
P-65 = 1	DI2 = T3 only			 Run Reverse		 Run Forward
P-65 = 2	DI2 = T3 AND Switch REV		AND	 Run Reverse		

4.9. Using the Internal Pot (Local Control Versions Only)

On switched drives, the built-in pot (indicated) may be used to directly control the signal level applied to analog input 1, and therefore the output frequency (motor speed).

To select the built-in pot as the signal source for analog input 1, set P-16 = 8 In-pot.

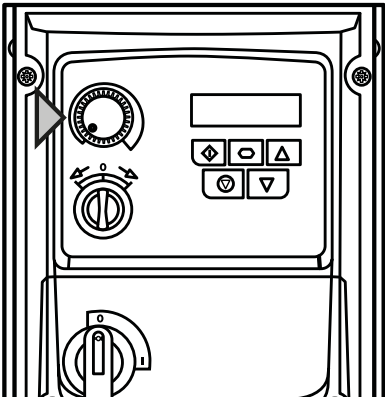

4.10. Control Terminal Connections

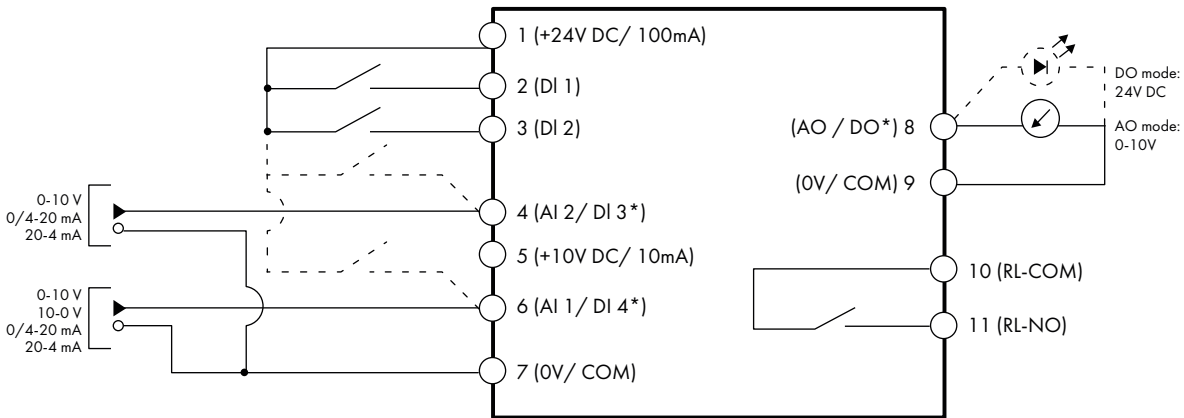

NOTE

* Dashed lines shows connection for analog inputs and output in digital mode

Key	Default Function		Sec.	Page
	Open	Closed		
1	+24V DC	24 Volt DC Output	On-board +24V DC Supply (100mA)	
2	DI 1	Digital Input 1 (Run Enable)	STOP	RUN
3	DI 2	Digital Input 2	FORWARD	REVERSE
4	AI 2 / DI 3	Analog Input 2 / Digital Input 3	AI 1 Reference	Preset Speed 1 (P-20)
5	+10V DC	+10V DC Output	On-board +10V DC Supply (10 mA)	
6	AI 1 / DI 4	Analog Input 1 / Digital Input 4	Speed Reference 1 (0-10V)	
7	0V / COM	0 Volt Common	0V Common for AI/AO/DI/DO	
8	AO	Analog Output	Motor Speed (0-10V)	
9	0V / COM	0 Volt Common	0V Common for AI/AO/DI/DO	
10	RL-COM	Relay Output Common	Drive Faulty	Drive Healthy
11	RL-NO	Relay Output NO Contact		

NOTE

Digital Inputs: Logic High = 8-30V DC (30V DC max)

Analog Output: 0 – 10 Volt (20mA max)

Relay Output: 6A/250V AC, 5A/30V DC (resistive load)

4.10.1. Analog Output

The analog output function may be configured using parameter P-25, which is described in section 6.2. Parameter List on page 23. The output has two operating modes, dependent on the parameter selection:

- Analog Mode
 - The output is a 0 – 10 volt DC signal, 20mA max load current.
- Digital Mode
 - The output is 24 volt DC, 20mA max load current.

4.10.2. Relay Output

The relay output function may be configured using parameter P-18, which is described in section 6.2. Parameter List on page 23.

4.10.3. Analog Inputs

Two analog inputs are available, which may also be used as Digital Inputs if required. The signal formats are selected by parameters as follows:

- Analog Input 1 Format Selection Parameter P-16.
- Analog Input 2 Format Selection Parameter P-47.

These parameters are described more fully in section 6.3.3 Input and Output Functions on page 28.

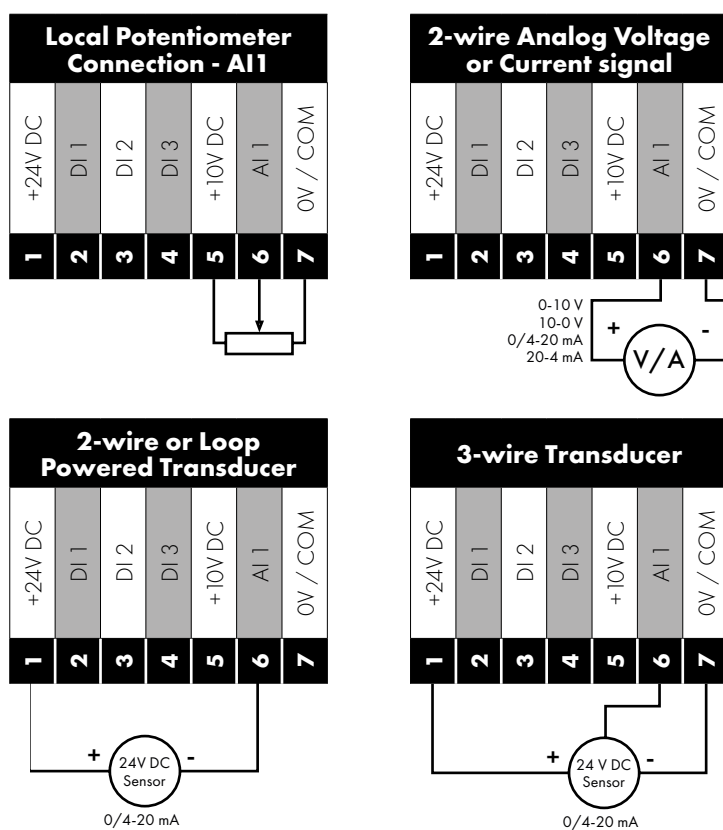

The function of the analog input, e.g. for speed reference or PID feedback for example is defined by parameters P-15. The function of these parameters and available options is described in section 7. Analog and Digital Input Macro Configurations on page 40.

4.10.4. Digital Inputs

Up to four digital inputs are available. The function of the inputs is defined by parameters P-12 and P-15, which are explained in section 7. Analog and Digital Input Macro Configurations on page 40.

4.11. Motor Thermal Overload Protection

4.11.1. Internal Thermal Overload Protection

The drive has an built-in motor thermal overload function; this is in the form of an "I.t-trP" trip after delivering >100% of the value set in P-08 for a sustained period of time (e.g. 150% for 60 seconds).

4.11.2. Motor Thermistor Connection

Where a motor thermistor is to be used, it should be connected as follows:

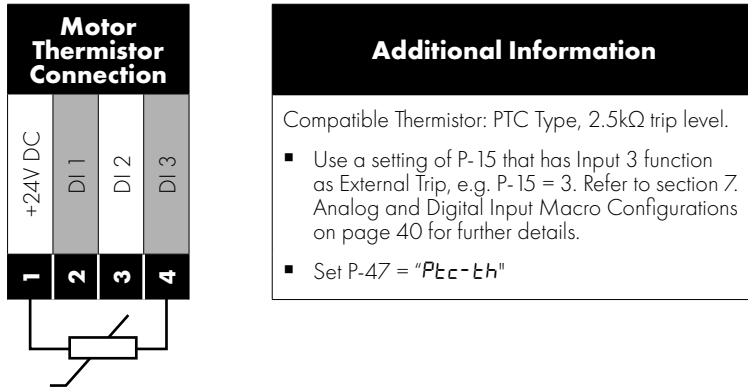

Refer to section 7. Analog and Digital Input Macro Configurations for further information regarding configuration of the input functions.

4.12. EMC Compliant Installation

Category	Supply Cable Type	Motor Cable Type	Control Cables	Maximum Permissible Motor Cable Length
C1 ⁶	Shielded ¹	Shielded ^{1,5}	Shielded ⁴	1M / 5M ⁷
C2	Shielded ²	Shielded ^{1,5}		5M / 25M ⁷
C3	Unshielded ³	Shielded ²		25M / 100M ⁷

- 1 A screened (shielded) cable suitable for fixed installation with the relevant mains voltage in use. Braided or twisted type screened cable where the screen covers at least 85% of the cable surface area, designed with low impedance to HF signals. Installation of a standard cable within a suitable steel or copper tube is also acceptable.
- 2 A cable suitable for fixed installation with relevant mains voltage with a concentric protection wire. Installation of a standard cable within a suitable steel or copper tube is also acceptable.
- 3 A cable suitable for fixed installation with relevant mains voltage. A shielded type cable is not necessary.
- 4 A shielded cable with low impedance shield. Twisted pair cable is recommended for analog signals.
- 5 The cable screen should be terminated at the motor end using an EMC type gland allowing connection to the motor body through the largest possible surface area. Where drives are mounted in a steel control panel enclosure, the cable screen may be terminated directly to the control panel using a suitable EMC clamp or gland, as close to the drive as possible. For IP66 drives, connect the motor cable screen to the internal ground clamp.
- 6 Compliance with category C1 conducted emissions only is achieved. For compliance with category C1 radiated emissions, additional measures may be required, contact your Sales Partner for further assistance. Frame size 3 single phase 230V input is not C1 compliant.
- 7 Permissible cable length with additional external EMC filter.

4.13. Optional Brake Resistor

Optidrive E3 Frame Size 2 and above units have a built-in Brake Transistor. This allows an external resistor to be connected to the drive to provide improved braking torque in applications that require this.

The brake resistor should be connected to the "+" and "BR" terminals as shown in the diagrams in sections 4.2. Connection Diagram.

The voltage level at these terminals may exceed 800VDC.
 Stored charge may be present after disconnecting the mains power.
 Allow a minimum of 10 minutes discharge after power off before attempting any connection to these terminals.

Suitable resistors and guidance on selection can be obtained from your Invertek Sales Partner. The brake transistor is enabled here by setting P-34 > 0. See section 6. Parameters for more information.

Dynamic Brake Transistor with Thermal Overload Protection

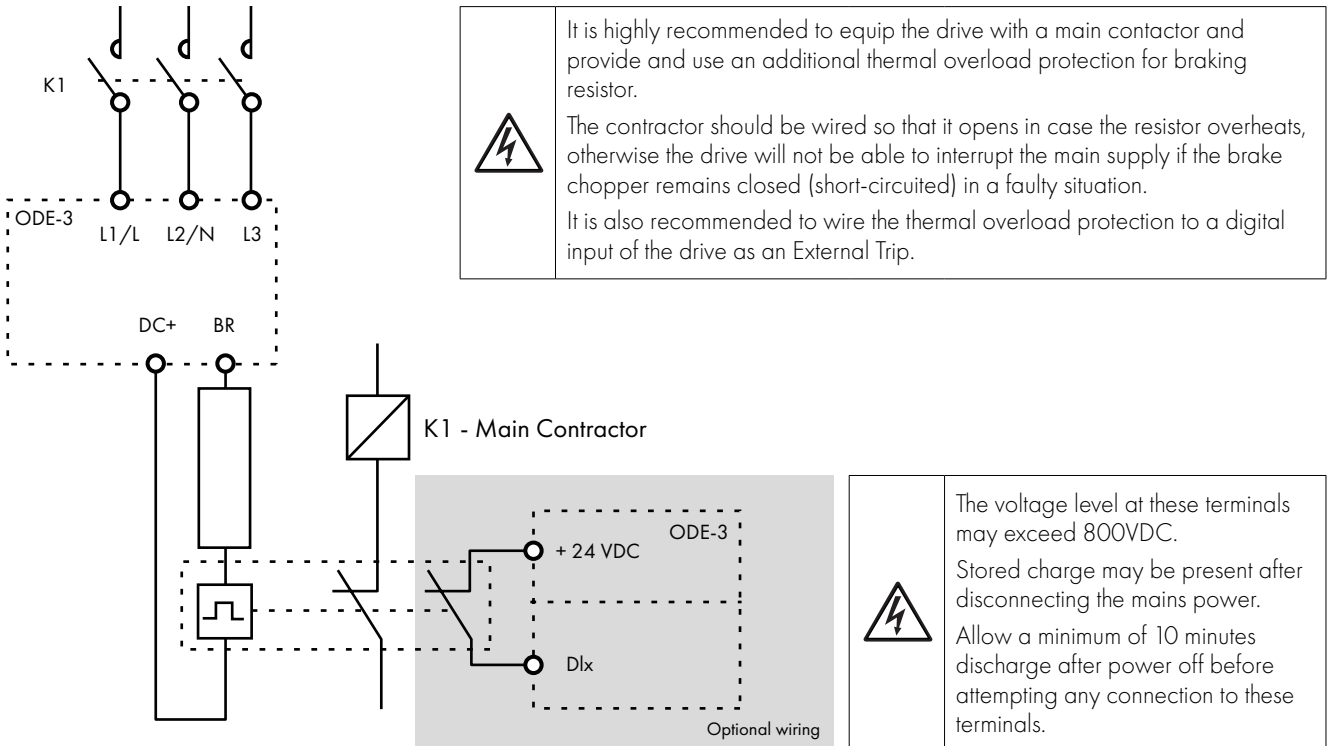

It is highly recommended to equip the drive with a main contactor and provide and use an additional thermal overload protection for braking resistor.

⚡ The contractor should be wired so that it opens in case the resistor overheats, otherwise the drive will not be able to interrupt the main supply if the brake chopper remains closed (short-circuited) in a faulty situation.

It is also recommended to wire the thermal overload protection to a digital input of the drive as an External Trip.

⚡ The voltage level at these terminals may exceed 800VDC.

Stored charge may be present after disconnecting the mains power.





Allow a minimum of 10 minutes discharge after power off before attempting any connection to these terminals.

Thermal Overload / Brake Resistor with internal Over Temperature switch

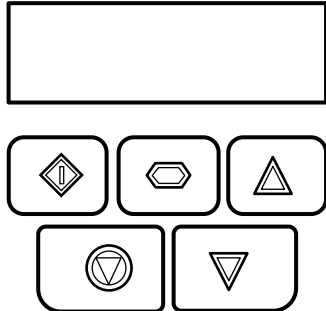

5. Operation

5.1. Managing the Keypad



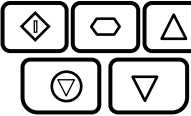
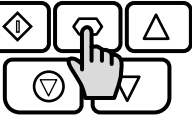
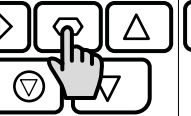

The drive is configured and its operation monitored via the keypad and display.

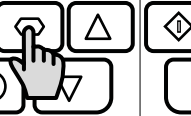
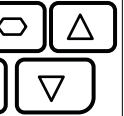
	NAVIGATE	Used to display real-time information, to access and exit parameter edit mode and to store parameter changes.	
	UP	Used to increase speed in real-time mode or to increase parameter values in parameter edit mode.	
	DOWN	Used to decrease speed in real-time mode or to decrease parameter values in parameter edit mode.	
	RESET / STOP	Used to reset a tripped drive. When in Keypad mode is used to Stop a running drive.	
	START	When in keypad mode, used to Start a stopped drive or to reverse the direction of rotation if bi-directional keypad mode is enabled.	

5.2. Operating Displays

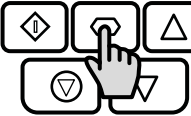
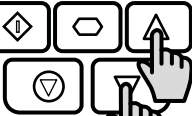
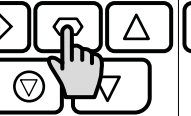
<i>Stop</i>	<i>H 50.0</i>	<i>A 2.3</i>	<i>P 1.50</i>	<i>1500</i>	<i>F irE</i>
					
Drive Stopped / Disabled	Drive is enabled / running, display shows the output frequency (Hz)	Press the Navigate key for < 1 second. The display will show the motor current (Amps)	Press the Navigate key for < 1 second. The display will show the motor power (kW)	If P-10 > 0, pressing the Navigate key for < 1 second will display the motor speed (RPM)	Drive is in fire mode and can't be reset until fire mode is deactivated

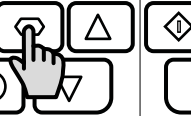
5.3. Changing Parameters

<i>Stop</i>	<i>P-01</i>	<i>P-08</i>	<i>10</i>	<i>P-08</i>	<i>P-08</i>
					
Press and hold the Navigate key > 2 seconds	Use the up and down keys to select the required parameter	Press the Navigate key for < 1 second	Adjust the value using the Up and Down keys	Press for < 1 second to return to the parameter menu	Press for > 2 seconds to return to the operating display

5.4. Read Only Parameter Access

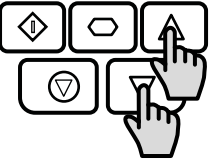
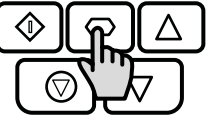
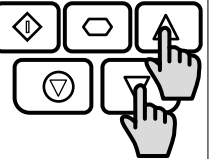
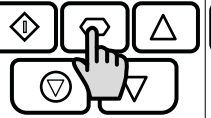
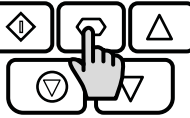
StoP	P-00	P00-01	P00-08	330	StoP
					
Press and hold the Navigate key > 2 seconds	Use the up and down keys to select P-00	Press the Navigate key for < 1 second	Use the up and down keys to select the required Read Only parameter	Press the Navigate key for < 1 second to display the value	Press and hold the Navigate key > 2 seconds to return to the operating display

5.5. Resetting Parameters

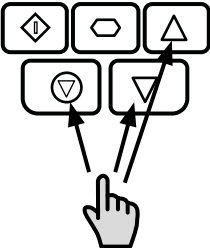
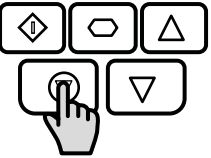
P-dEF	StoP
	
To reset parameter values to their factory default settings, press and hold Up, Down and Stop buttons for > 2 seconds. The display will show "P-dEF"	Press the Stop key. The display will show "StoP"

5.6. Resetting a Fault

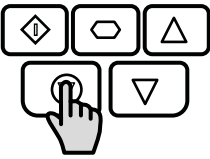
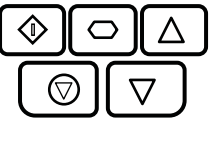
0-1	StoP
	
Press the Stop key. The display will show "StoP"	

5.7. LED Display

Optidrive E3 has a built-in 6 Digit 7 Segment LED Display. In order to display certain warnings, the following methods are used:

5.7.1 LED Display Layout

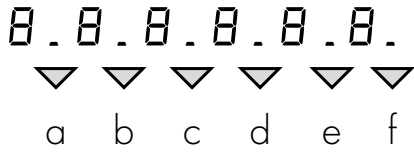

5.7.2 LED Display Meanings

LED Segments	Behaviour	Meaning
a, b, c, d, e, f	Flashing all together	Overload, motor output current exceeds P-08
a and f	Flashing alternately	Mains Loss (Incoming AC power has been removed)
a	Flashing	Fire Mode Active

6. Parameters

6.1. Standard Parameters

The parameter set is arranged in Groups according to the following structure:

Parameter Group	Range	Access Level	Access Type
P00	P00-01 to P00-20	Extended	Read Only
	P00-21 to P00-50	Advanced	Read Only
Basic Parameters	P-01 to P-14	Basic	Read / Write
Extended Parameters	P-15 to P-50	Extended	Read / Write
Advanced Parameters	P-51 to P-60	Advanced	Read / Write

Access to all parameter groups is controlled by setting P-14 as follows:

P-14 = P-37 (Factory setting: 101) Allows Extended Parameter Access

P-14 = P-37 + 100 (Factory Setting: 201) Allows Advanced Parameter Access

In order to prevent possible damage to the drive and connected machinery, certain parameters are locked during operation of the drive to prevent change. In the case that the drive is enabled, and the user tries to change the parameter, an "L" is shown on the left of the display.

6.2. Parameter List

6.2.1. Standard Parameters

Par.	Function	Page No.
P-01	Maximum Frequency / Speed Limit	26
P-02	Minimum Frequency / Speed Limit	26
P-03	Acceleration Ramp Time	26
P-04	Deceleration Ramp Time	26
P-05	Stop Mode / Mains Loss Control	27
P-06	Energy Optimiser	27
P-07	Motor Rated Voltage / kE (PM / BLDC)	25
P-08	Motor Rated Current	25
P-09	Motor Rated Frequency	25
P-10	Motor Rated Speed	25
P-11	Low Frequency Torque Boost	25
P-12	Primary Command Source	28
P-13	Application Mode	27
P-14	Extended Menu Access code	30

6.2.2. Extended Parameters

Par.	Function	Page No.
P-15	Digital Input Function	30
P-16	Analog Input 1 Format	28
P-17	Effective Switching Frequency	28
P-18	Relay Output Function	29
P-19	Relay Threshold	29
P-20	Preset Frequency / Speed 1	30
P-21	Preset Frequency / Speed 2	30
P-22	Preset Frequency / Speed 3	30
P-23	Preset Frequency / Speed 4	30
P-24	Second Ramp Time	27

Par.	Function	Page No.
P-25	Analog Output Function	29
P-26	Skip Frequency Band Width	32
P-27	Skip Frequency Center Point	32
P-28	V/F Adjustment Voltage	32
P-29	V/F Adjustment Frequency	32
P-30	Start/ Restart / Fire Mode Config	31
P-31	Keypad Start Mode	31
P-32	Index 1: DC Injection Duration	32
	Index 2: DC Injection Braking Mode	32
P-33	Spin Start Enable	32
P-34	Brake Chopper Enable (Not Size 1)	33
P-35	Analog Input 1/Slave Speed Scaling	29
P-36	Communication Configuration	34
P-37	Extended Menu Access Code	30
P-38	Parameter Lock	30
P-39	Analog Input 1 Offset	29
P-40	Index 1: Display Scaling Factor	33
	Index 2: Display Scaling Source	33
P-41	PI Proportional Gain	33
P-42	PI Integral Time	33
P-43	PI Operating Mode	33
P-44	PI Reference (Setpoint) Source	33
P-45	PI Digital Reference	33
P-46	PI Feedback Source	33
P-47	Analog Input 2 Signal Format	28
P-48	Standby Mode Timer	34
P-49	PI Error Wake Up Level	34
P-50	Relay Output Hysteresis	29

6.2.3. Advanced Parameters

Par.	Function	Page No.
P-51	Motor Control Mode	35
P-52	Auto-tune Enable	35
P-53	Vector Speed Control P-gain	35
P-54	Maximum Current Limit	34
P-55	Motor Stator Resistance	35
P-56	Motor Stator Inductance (d)	35
P-57	Motor Stator Inductance (q)	35
P-58	DC Injection Frequency / Speed	32
P-59	DC Injection Current	32
P-60	Overload Management	36
P-61	Ethernet Service Option	36
P-62	Ethernet Service Timeout	36
P-63	Modbus Mode Selection	36
P-64	IP66 DI1 Source	36
P-65	IP66 DI2 Source	36

6.3. Parameter Functions

The following sections highlight the parameters relevant to certain functions in the drive firmware. Parameters are grouped according to the function.

6.3.1. Basic Functions

Motor Nameplate Settings (relevant parameters)

Par.	Description	Minimum	Maximum	Default	Units
P-07	Motor Rated Voltage / kV	0	250 / 500	230 / 400	V
	For Induction Motors, this parameter should be set to the rated (nameplate) voltage of the motor (Volts). For Permanent Magnet or Brushless DC Motors, it should be set to the Back EMF at rated speed.				
P-08	Motor Rated Current	Drive Rating Dependent			A
	This parameter should be set to the rated (nameplate) current of the motor.				
P-09	Motor Rated Frequency	10	500	50 (60)	Hz
	This parameter should be set to the rated (nameplate) frequency of the motor.				

When commissioning the drive, it is necessary to enter certain information about the motor into the drive to ensure the drive is optimised to control the connected motor and additionally to prevent damage to the motor.

For standard induction motors, the parameters are listed below.

For alternative motor types, refer to the later relevant sections for each motor type.

Working in RPM (relevant parameters)

Par.	Description	Minimum	Maximum	Default	Units
P-10	Motor Rated Speed	0	30000	0	RPM
	This parameter can optionally be set to the rated (nameplate) RPM of the motor. When set to the default value of zero, all speed related parameters are displayed in Hz and the slip compensation (where motor speed is maintained at a constant value regardless of applied load) for the motor is disabled. Entering the value from the motor nameplate enables the slip compensation function, and the Optidrive display will now show motor speed in RPM. All speed related parameters, such as Minimum and Maximum Speed, Preset Speeds etc. will also be displayed in RPM.				
	NOTE If P-09 value is changed, P-10 value is reset to 0.				

Optidrive E3 normally uses frequency for all speed related parameters, e.g. Minimum and Maximum Output Frequency. It is also possible to work directly in RPM, by setting the above parameter to the relevant rated speed from the connected motor nameplate.

When set to the default value of zero, all speed related parameters are displayed in Hz, and slip compensation for the motor is disabled. Entering the value from the motor nameplate enables the slip compensation function, and the Optidrive display will also now show motor speed in RPM. All speed related parameters, such as Minimum and Maximum Speed, Preset Speeds etc. will also be displayed in RPM.

NOTE If P-09 value is changed, P-10 value is reset to 0.

Low Frequency Torque Boost (relevant parameters)

Par.	Description	Minimum	Maximum	Default	Units
P-11	Low Frequency Torque Boost	0.0	Drive Dependent		%
	Low frequency torque can be improved by increasing this parameter. Excessive boost levels may however result in high motor current and increased risk of tripping on Over Current or Motor Overload (refer to section 11.1. Fault Code Messages). This parameter operates in conjunction with P-51 (Motor Control Mode) as follows:				
	P-51	P-11			
	0	0	Boost is automatically calculated according to autotune data.		
		>0	Voltage boost = $P-11 \times P-07$. This voltage is applied at 0.0Hz, and linearly reduced until $P-09 / 2$.		
	1	All	Voltage boost = $P-11 \times P-07$. This voltage is applied at 0.0Hz, and linearly reduced until $P-09 / 2$.		
	2, 3, 4	All	Boost current level = $4 * P-11 * P-08$.		
	For IM motors, when P-51 = 0 or 1, a suitable setting can usually be found by operating the motor under very low or no load conditions at approximately 5Hz, and adjusting P-11 until the motor current is approximately the magnetising current (if known) or in the range shown below. Frame Size 1: 60 – 80% of motor rated current. Frame Size 2: 50 – 60% of motor rated current. Frame Size 3: 40 – 50% of motor rated current. Frame Size 4: 35 – 45% of motor rated current.				

Low Frequency Torque Boost is used to increase the applied motor voltage and hence current at low output frequencies. This can improve low speed and starting torque. Increasing the boost level will increase motor current at low speed, which may result in the motor temperature rising - force ventilation or additional cooling of the motor may then be required. In general, the lower the motor power, the higher the boost setting that may be safely used.

For IM motor types (P-51 = 0 or 1), the value entered determines the voltage applied to the motor at 0.0Hz relative to P-07 setting. e.g.

- P-07 = 400V
- P-11 = 2%
- Output voltage applied to the motor at 0.0Hz = 2% x 400V = 8V.

This boost voltage is then linearly reduced up to 50% of the motor rated speed (P-09).

When operating with alternative motor types (P-51 = 2, 3 or 4) this parameter is used to set an additional boost current which is injected into the motor. The actual current level is defined as $4 * P-11 * P-08$.

This additional current is injected between 0.0Hz and 10% of rated frequency. Above this point, the boost current is reduced according to the diagram below.

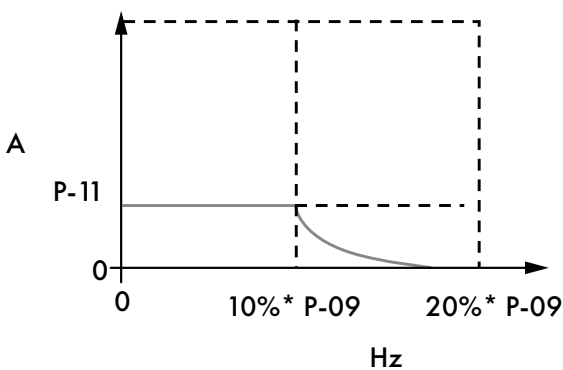

Speed Limits (relevant parameters)

These parameters define the range of output frequency and therefore the speed range through which the drive will operate.

As described above:

- If P-10 = 0, Values are Hz
- If P-10 <> 0, Values are RPM

Dependent on the speed reference selection, the operation will be as follows:

For Analog Speed Reference: Applying 0% analog signal results in the speed reference of P-02. Applying 100% signal results in the speed reference of P-01. Scaling between these points is linear.

Scaling may be adjusted on Analog Input 1 only using the AI1 Scaling & Offset function shown on page 29.

The value used for the speed reference:

Par.	Description	Minimum	Maximum	Default	Units
P-01	Maximum Frequency / Speed Limit	P-02	500.0	50.0 (60.0)	Hz / RPM
	Maximum output frequency or motor speed limit – Hz or RPM. If P-10 >0, the value entered / displayed is in RPM.				
P-02	Minimum Frequency / Speed Limit	0.0	P-01	20.0	Hz / RPM
	Minimum speed limit – Hz or RPM. If P-10 >0, the value entered / displayed is in RPM.				

Acceleration and Deceleration (relevant parameters)

Par.	Description	Minimum	Maximum	Default	Units
P-03	Acceleration Ramp Time	0.00	600.0	5.0	s
	Acceleration ramp time from zero Hz / RPM to base frequency (P-09) in seconds.				
P-04	Deceleration Ramp Time	0.00	600.0	5.0	s
	Deceleration ramp time from base frequency (P-09) to standstill in seconds. When set to 0.00, the value of P-24 is used.				

Second Deceleration Time

Par.	Description	Minimum	Maximum	Default	Units
P-24	Second Ramp Time (Fast Stop)	0.00	6000.0	0.0	s
This parameter allows an alternative deceleration ramp down time to be programmed into the Optidrive, which can be selected by digital inputs (dependent on the setting of P-15) or selected automatically in the case of a mains power loss if P-05 = 2 or 3. When set to 0.00, the drive will coast to stop.					

Stopping Mode

Par.	Description	Minimum	Maximum	Default	Units
P-05	Stop Mode / Mains Loss Control	0	4	0	-
Selects the stopping mode of the drive, and the behaviour in response to a loss of mains power supply during operation.					
	Setting	On Disable	On Mains Loss		
	0	Ramp to Stop (P-04)	Ride Through (Recover energy from load to maintain operation)		
	1	Coast	Coast		
	2	Ramp to Stop (P-04)	Fast Ramp to Stop (P-24), Coast if P-24 = 0		
	3	Ramp to Stop (P-04) with AC Flux Braking	Fast Ramp to Stop (P-24), Coast if P-24 = 0		
	4	Ramp to Stop (P-04)	No action		

Energy Optimisier

This parameter configures the energy saving functions of the drive as follows:

Motor Energy Optimisation: Reduces energy losses in the motor under part load conditions by reducing motor flux. This function should not be used in applications which have large sudden load step changes, or for PI control applications, as it may cause instability in the control or over current trip.

Drive Energy Optimiser: Reduces the energy losses in the drive at higher output frequencies by reducing switching losses. This may lead to vibration or instability in the motor under light load conditions.

Par.	Description	Minimum	Maximum	Default	Units
P-06	Energy Optimiser	0	3	0	-
	Setting	Motor Energy Optimiser	Drive Energy Optimiser		
	0	Disabled	Disabled		
	1	Enabled	Disabled		
	2	Disabled	Enabled		
	3	Enabled	Enabled		

Application Macros (relevant parameters)

Par.	Description	Minimum	Maximum	Default	Units	
P-13	Application Mode	0	2	0	-	
Provides a quick set up to configure key parameters according to the intended application of the drive. Parameters are preset according to the table. 0: Industrial Mode. Intended for general purpose applications. 1: Pump Mode. Intended for centrifugal pump applications. 2: Fan Mode. Intended for Fan applications.						
	Setting	Application	Current Limit (P-54)	Torque Characteristic	Spin Start (P-33)	Thermal Overload Limit Reaction (P-60 Index 2)
	0	General	150%	Constant	0: Off	0: Trip
	1	Pump	110%	Variable	0: Off	1: Current Limit Reduction
	2	Fan	110%	Variable	2: On	1: Current Limit Reduction

6.3.2 Control Modes

Par.	Description	Minimum	Maximum	Default	Units
P-12	Primary Command Source	0	9	0	-
	<p>0: Terminal control. The drive responds directly to signals applied to the control terminals.</p> <p>1: Keypad control - uni-directional. The drive can be controlled in the forward direction only using the internal keypad, or an external remote Keypad.</p> <p>2: Keypad control - bi-directional. The drive can be controlled in the forward and reverse directions using the internal keypad, or an external remote Keypad. Pressing the keypad START button toggles between forward and reverse.</p> <p>3: Modbus RTU control with internal ramps active. Control via Modbus RTU (RS485) using the internal Accel / Decel ramps.</p> <p>4: Modbus RTU control with internal ramps inactive. Control via Modbus RTU (RS485) interface with Accel / Decel ramps updated via Modbus.</p> <p>5: PI control. User PI control with external feedback signal.</p> <p>6: PI control added to analog input 1. PI control with external feedback signal and summation with analog input 1.</p> <p>7: CANopen control with internal ramps active. Control via CAN (RS485) using the internal Accel / Decel ramps.</p> <p>8: CANopen control with internal ramps inactive. Control via CAN (RS485) interface with Accel / Decel ramps updated via CAN.</p> <p>9: Slave mode. Control via a connected Invertek drive in Master Mode. Slave drive address must be > 1.</p> <p>NOTE When P-12 = 1, 2, 3, 4, 7, 8 or 9, an enable signal must still be provided at the control terminals, digital input 1.</p>				

6.3.3 Input and Output Functions

Analog Inputs - Format (relevant parameters)

Par.	Description	Minimum	Maximum	Default	Units
P-16	Analog Input 1 Format	See Below		In-pot	-
	<p><i>U 0-10</i> = Uni-polar 0 to 10 Volt Signal. The drive will remain at minimum speed (P-02) if the analog reference after scaling and offset are applied is =<0.0%. 100% signal means the output frequency / speed will be the value set in P-01.</p> <p><i>b 0-10</i> = Uni-polar 0 to 10 Volt Signal, bi-directional operation. The drive will operate the motor in the reverse direction of rotation if the analog reference after scaling and offset are applied is <0.0%. E.g. for bidirectional control from a 0 – 10 volt signal, set P-35 = 200.0%, P-39 = 50.0%.</p> <p><i>A 0-20</i> = 0 to 20mA Signal.</p> <p><i>t 4-20</i> = 4 to 20mA Signal, the Optidrive will trip and show the fault code 4-20F 500ms after the signal level falls below 3mA.</p> <p><i>r 4-20</i> = 4 to 20mA Signal, the Optidrive will run at Preset Speed 1 (P-20) if the signal level falls below 3mA.</p> <p><i>t 20-4</i> = 20 to 4mA Signal, the Optidrive will trip and show the fault code 4-20F 500ms after the signal level falls below 3mA.</p> <p><i>r 20-4</i> = 20 to 4mA Signal, the Optidrive will run at Preset Speed 1 (P-20) if the signal level falls below 3mA.</p> <p><i>U 10-0</i> = 10 to 0 Volt Signal (Uni-polar). The drive will operate at Maximum Frequency / Speed if the analog reference after scaling and offset are applied is =<0.0%.</p> <p><i>I n-Pot</i> = Integrated Potentiometer.</p>				
P-17	Effective Switching Frequency	4	32	8	kHz
	Sets maximum effective switching frequency of the drive. If " rEd " is displayed when the parameter is viewed, the switching frequency has been reduced to the level in P00-32 due to excessive drive heatsink temperature.				
P-47	Analog Input 2 Format	-	-	U0-10-	-
	<p><i>U 0-10</i> = 0 to 10 Volt Signal.</p> <p><i>A 0-20</i> = 0 to 20mA Signal.</p> <p><i>t 4-20</i> = 4 to 20mA Signal, the Optidrive will trip and show the fault code 4-20F 500ms after the signal level falls below 3mA.</p> <p><i>r 4-20</i> = 4 to 20mA Signal, the Optidrive will run at Preset Speed 1 (P-20) if the signal level falls below 3mA.</p> <p><i>t 20-4</i> = 20 to 4mA Signal, the Optidrive will trip and show the fault code 4-20F 500ms after the signal level falls below 3mA.</p> <p><i>r 20-4</i> = 20 to 4mA Signal, the Optidrive will run at Preset Speed 1 (P-20) if the signal level falls below 3mA.</p> <p><i>Ptc-t</i> = Use for motor thermistor measurement, valid with any setting of P-15 that has Input 3 as E-Trip. Trip level: 1.5kΩ, reset 1kΩ.</p>				

Analog Inputs - All Scaling & Offset (relevant parameters)

Par.	Description	Minimum	Maximum	Default	Units
P-35	Analog Input 1/Slave Speed Scaling	0.0	2000.0	100.0	%
	<p>Analog Input 1 Scaling. The analog input signal level is multiplied by this factor, e.g. if P-16 is set for a 0 – 10V signal, and the scaling factor is set to 200.0%, a 5 volt input will result in the drive running at maximum frequency / speed (P-01).</p> <p>Slave Speed Scaling. When operating in Slave Mode (P-12 = 9), the operating speed of the drive will be the Master speed multiplied by this factor, limited by the minimum and maximum speeds.</p>				
P-39	Analog Input 1 Offset	-500.0	500.0	0.0	%
	<p>Sets an offset, as a percentage of the full scale range of the input, which is applied to the analog input signal. This parameter operates in conjunction with P-35, and the resultant value can be displayed in P00-01.</p> <p>The resultant value is defined as a percentage, according to the following: $P00-01 = (\text{Applied Signal Level}(\%) - P-39) \times P-35$.</p>				

Relay Output Functions (relevant parameters)

Par.	Description	Minimum	Maximum	Default	Units
P-18	Relay Output Function	0	12	1	-
	<p>Selects the function assigned to the relay output. The relay has two output terminals, Logic 1 indicates the relay is active, and therefore terminals 10 and 11 will be connected.</p> <p>0: Drive running. Logic 1 when the motor is enabled.</p> <p>1: Drive healthy. Logic 1 when power is applied to the drive and no fault exists.</p> <p>2: At speed. Logic 1 when the output frequency matches the setpoint frequency.</p> <p>3: Drive tripped. Logic 1 when the drive is in a fault condition.</p> <p>4: Motor speed >= limit. Logic 1 when the output frequency exceeds the adjustable limit set in P-19.</p> <p>5: Motor current >=limit. Logic 1 when the motor current exceeds the adjustable limit set in P-19.</p> <p>6: Motor speed <limit. Logic 1 when the output frequency is below the adjustable limit set in P-19.</p> <p>7: Motor current <limit. Logic 1 when the motor current is below the adjustable limit set in P-19.</p> <p>8: Analog input 2 >=limit. Logic 1 when the signal applied to analog input 2 exceeds the adjustable limit set in P-19.</p> <p>9: Drive ready to run. Logic 1 when the drive is ready to run, no trip present.</p> <p>10: Fire Mode Active. Logic 1 when Fire Mode is activated.</p> <p>11: Output Frequency > Limit and not Fire Mode. As setting 4 however the output relay state does not change if the drive is in Fire Mode.</p> <p>12: Fieldbus. Status is controlled by bit 8 of the fieldbus control word. Fieldbus type is selected by P-12.</p>				
P-19	Relay Threshold	0.0	200.0	100.0	%
	Adjustable threshold level used in conjunction with settings 4 to 8 of P-18.				
P-50	Relay Output Hysteresis	0.0	100.0	0.0	%
	Sets the hysteresis level for P-19 to prevent the output relay chattering when close to the threshold.				

Analog Output Functions (relevant parameters)

Par.	Description	Minimum	Maximum	Default	Units
P-25	Analog Output Function	0	12	8	-
	<p>Digital Output Mode. Logic 1 = +24V DC</p> <p>0: Drive running. Logic 1 when the Optidrive is enabled (Running).</p> <p>1: Drive healthy. Logic 1 When no Fault condition exists on the drive.</p> <p>2: At speed. Logic 1 when the output frequency matches the setpoint frequency.</p> <p>3: Drive tripped. Logic 1 when the drive is in a fault condition.</p> <p>4: Motor speed >= limit. Logic 1 when the output frequency exceeds the adjustable limit set in P-19.</p> <p>5: Motor current >=limit. Logic 1 when the motor current exceeds the adjustable limit set in P-19.</p> <p>6: Motor speed <limit. Logic 1 when the output frequency is below the adjustable limit set in P-19.</p> <p>7: Motor current <limit. Logic 1 when the motor current is below the adjustable limit set in P-19.</p> <p>Analog Output Mode</p> <p>8: Motor speed. 0 to P-01, resolution 0.1Hz.</p> <p>9: Motor current. 0 to 200% of P-08, resolution 0.1A.</p> <p>10: Motor power. 0 – 200% of drive rated power.</p> <p>11: Motor torque. 0 – 200% of P-08, resolution 0.1A.</p> <p>12: Fieldbus. The output state is digitally controlled by the bit 9 of the fieldbus control word. Fieldbus type is selected by P-12.</p>				
P-19	Relay Threshold	0.0	200.0	100.0	%
	Adjustable threshold level used in conjunction with settings 4 to 8 of P-25.				

6.3.4. Common Functions

Parameter Access Control and Locking (relevant parameters)

Par.	Description	Minimum	Maximum	Default	Units
P-14	Extended Menu Access	0	65535	0	-
	Enables access to Extended and Advanced Parameter Groups. This parameter must be set to the value programmed in P-37 (default: 101) to view and adjust Extended Parameters and value of P-37 + 100 to view and adjust Advanced Parameters. The code may be changed by the user in P-37 if desired.				
P-37	Extended Menu Access Code	0	9999	101	-
	Defines the access code which must be entered in P-14 to access parameters above P-14.				
P-38	Parameter Lock	0	1	0	-
	0: Unlocked. All parameters can be accessed and changed. 1: Locked. Parameter values can be displayed, but cannot be changed except P-38.				

Local/Remote (relevant parameters)

Par.	Description	Minimum	Maximum	Default	Units
P-15	Digital Input Function	0	19	0	-
	Defines the function of the digital inputs depending on the control mode setting in P-12. See section 7. Analog and Digital Input Macro Configurations for more information.				

Preset Speeds (relevant parameters)

Par.	Description	Minimum	Maximum	Default	Units
P-15	Digital Input Function Select	0	19	0	-
	Defines the function of the digital inputs depending on the control mode setting in P-12. See section 7. Analog and Digital Input Macro Configurations for more information.				
P-20	Preset Frequency / Speed 1	-P-01	P-01	5.0	Hz / RPM
P-21	Preset Frequency / Speed 2	-P-01	P-01	25.0	Hz / RPM
P-22	Preset Frequency / Speed 3	-P-01	P-01	40.0	Hz / RPM
P-23	Preset Frequency / Speed 4	-P-01	P-01	P-09	Hz / RPM
	Preset Speeds / Frequencies selected by digital inputs depending on the setting of P-15. If P-10 = 0, the values are entered as Hz. If P-10 > 0, the values are entered as RPM. NOTE Changing the value of P-09 will reset all values to factory default settings.				

Start Mode, Auto Restart and Fire Mode (relevant parameters)

Par.	Description	Minimum	Maximum	Default	Units
P-15	Digital Input Function	0	19	0	-
	Defines the function of the digital inputs depending on the control mode setting in P-12. See section 7. Analog and Digital Input Macro Configurations for more information.				

Par.	Description	Minimum	Maximum	Default	Units
P-30	Start/ Restart / Fire Mode Configuration				
	Index 1: Start Mode / Auto Restart	N/A	N/A	Edge-r	-
	<p>Selects whether the drive should start automatically if the enable input is present and latched during power on. Also configures the Automatic Restart function.</p> <p>EDGE-r: Following Power on or reset, the drive will not start if Digital Input 1 remains closed. The Input must be closed after a power on or reset to start the drive.</p> <p>AUTO-0: Following a Power On or Reset, the drive will automatically start if Digital Input 1 is closed.</p> <p>AUTO-1 To AUTO-5: Following a trip, the drive will make up to 5 attempts to restart at 20 second intervals. The numbers of restart attempts are counted, and if the drive fails to start on the final attempt, the drive will trip with a fault, and will require the user to manually reset the fault. The drive must be powered down to reset the counter.</p>				
	Index 2: Fire Mode Input Logic	0	1	0	-
	<p>Defines the operating logic when a setting of P-15 is used which includes Fire Mode, e.g. settings 15, 16 & 17.</p> <p>0: n.C: Normally Closed (NC) Input. Fire Mode active if input is open.</p> <p>1: n.O: Normally Open (NO) Input. Fire Mode active if input is closed.</p> <p>2: F-N.C: Normally Closed (NC) Input, Fixed Speed. Fire Mode active if input is open. Fire Mode Speed is Preset Speed 4 (P-23).</p> <p>3: F-N.O: Normally Open (NO) Input, Fixed Speed. Fire Mode active if input is closed. Fire Mode Speed is Preset Speed 4 (P-23).</p>				
	Index 3: Fire Mode Input Latch	0	1	0	-
	<p>Defines the input type when a setting of P-15 is used which includes Fire Mode, e.g. settings 15, 16 & 17.</p> <p>0: Off. The drive will remain in Fire Mode, only as long the fire mode input signal remains (Normally Open or Normally Closed operation is supported depending on Index 2 setting).</p> <p>1: On. Fire Mode is activated by a momentary signal on the input. Normally Open or Normally Closed operation is supported depending on Index 2 setting. The drive will remain in Fire Mode until disabled or powered off.</p>				
P-31	Keypad Start Mode	0	7	1	-
	<p>This parameter is active only when operating in Keypad Control Mode (P-12 = 1 or 2) or Modbus Mode (P-12 = 3 or 4). When settings 0, 1, 4 or 5 are used, the Keypad Start and Stop keys are active, and control terminals 1 and 2 must be linked together. Settings 2, 3, 6 and 7 allow the drive to be started from the control terminals directly, and the keypad Start and Stop keys are ignored.</p> <p>0: Minimum speed, keypad start</p> <p>1: Previous speed, keypad start</p> <p>2: Minimum speed, terminal start</p> <p>3: Previous speed, terminal start</p> <p>4: Current speed, keypad start</p> <p>5: Preset speed 4, keypad start</p> <p>6: Current speed, terminal start</p> <p>7: Preset speed 4, terminal start</p>				

Fire Mode

The Fire Mode function is designed to ensure continuous operation of the drive in emergency conditions until the drive is no longer capable of sustaining operation. The Fire Mode input may be a normally open (Close to Activate Fire Mode) or Normally Closed (Open to Activate Fire Mode) according to the setting of P-30 Index 2. In addition, the input may be momentary or maintained type, selected by P-30 Index 3.

This input may be linked to a fire control system to allow maintained operation in emergency conditions, e.g. to clear smoke or maintain air quality within that building.

The fire mode function is enabled when P-15 = 15, 16, 17 or 18, with Digital Input 3 assigned to activate fire mode.

Fire Mode disables the following protection features in the drive:

O-t (Heat-sink Over-Temperature), U-t (Drive Under Temperature), Th-Flt (Faulty Thermistor on Heat-sink), E-trip (External Trip), 4-20 F (4-20mA fault), Ph-Ib (Phase Imbalance), P-Loss (Input Phase Loss Trip), SC-trip (Communications Loss Trip), I.t-trip (Accumulated overload Trip).

The following faults will result in a drive trip, auto reset and restart:

O-Volt (Over Voltage on DC Bus), U-Volt (Under Voltage on DC Bus), h O-I (Fast Over-current Trip), O-I (Instantaneous over current on drive output), Out-F (Drive output fault, Output stage trip).

Switching Frequency Selection (relevant parameters)

Par.	Description	Minimum	Maximum	Default	Units
P-17	Effective Switching Frequency	4	32	8	kHz
	Sets maximum effective switching frequency of the drive. If "rEd" is displayed when the parameter is viewed, the switching frequency has been reduced to the level in P00-32 due to excessive drive heatsink temperature.				

Skip Frequency (relevant parameters)

Par.	Description	Minimum	Maximum	Default	Units
P-26	Skip Frequency Band Width	0.0	P-01	0.0	Hz / RPM
P-27	Skip Frequency Center Point	0.0	P-01	0.0	Hz / RPM
	The Skip Frequency function is used to avoid the Optidrive operating at a certain output frequency, for example at a frequency which causes mechanical resonance in a particular machine. Parameter P-27 defines the centre point of the skip frequency band, and is used in conjunction with P-26. The Optidrive output frequency will ramp through the defined band at the rates set in P-03 and P-04 respectively, and will not hold any output frequency within the defined band. If the frequency reference applied to the drive is within the band, the Optidrive output frequency will remain at the upper or lower limit of the band.				

V/F Characteristic Adjustment (relevant parameters)

Par.	Description	Minimum	Maximum	Default	Units
P-28	V/F Characteristic Adjustment Voltage	0	P-07	0	V
P-29	V/F Characteristic Adjustment Voltage	0.0	P-09	0.0	Hz
	This parameter in conjunction with P-28 sets a frequency point at which the voltage set in P-29 is applied to the motor. Care must be taken to avoid overheating and damaging the motor when using this feature.				

DC Injection Braking (relevant parameters)

Par.	Description	Minimum	Maximum	Default	Units
P-32	Index 1: DC Injection Duration	0.0	25.0	0.0	s
	Index 2: DC Injection Braking Mode	0	2	0	-
	Determined by Autotune, adjustment is not normally required.				
P-58	DC Injection Frequency / Speed	0.0	P-01	0.0	Hz / RPM
	Sets the speed at which DC injection current is applied during braking to Stop, allowing DC to be injected before the drive reaches zero speed if desired.				
P-59	DC Injection Current	0.0	100.0	20.0	%
	Sets the level of DC injection braking current applied according to the conditions set in P-32 and P-58.				

Spin Start (relevant parameters)

Par.	Description	Minimum	Maximum	Default	Units
P-33	Spin Start Enable	0	2	0	-
	0: Disabled 1: Enabled. When enabled, on start up the drive will attempt to determine if the motor is already rotating, and will begin to control the motor from its current speed. A short delay may be observed when starting motors which are not turning. 2: Enabled on Trip, Brown Out or Coast Stop. Spin start is only activated following the events listed, otherwise it is disabled.				

Dynamic braking (relevant parameters)

Par.	Description	Minimum	Maximum	Default	Units
P-34	Brake Chopper Enable (Not Size 1)	0	4	0	-
	<p>0: Disabled</p> <p>1: Enabled with software protection. Brake chopper enabled with software protection for a 200W continuous rated resistor.</p> <p>2: Enabled without software protection. Enables the internal brake chopper without software protection. An external thermal protection device should be fitted.</p> <p>3: Enabled with software protection on speed change only. As setting 1, however the Brake Chopper is only enabled during a change of the frequency setpoint, and is disabled during constant speed operation.</p> <p>4: Enabled without software protection on speed change only. As setting 2, however the Brake Chopper is only enabled during a change of the frequency setpoint, and is disabled during constant speed operation.</p>				

Display Scaling (relevant parameters)

Par.	Description	Minimum	Maximum	Default	Units
P-40	Index 1: Display Scaling Control	0.000	16.000	0.000	-
	Index 2: Display Scaling Source	0	3	0	-
	Allows the user to program the Optidrive to display an alternative output unit scaled from either output frequency (Hz), Motor Speed (RPM) or the signal level of PI feedback when operating in PI Mode.				
	Index 1: Used to set the scaling multiplier. The chosen source value is multiplied by this factor.				
	Index 2: Defines the scaling source as follows:				
	0: Motor Speed. Scaling is applied to the output frequency if P-10 = 0, or motor RPM if P-10 > 0.				
	1: Motor Current. Scaling is applied to the motor current value (Amps).				
	2: Analog Input 2 Signal Level. Scaling is applied to analog input 2 signal level, internally represented as 0 – 100.0%.				
	3: PI Feedback. Scaling is applied to the PI feedback selected by P-46, internally represented as 0 – 100.0%.				

PI Control (relevant parameters)

Par.	Description	Minimum	Maximum	Default	Units
P-41	PI Proportional Gain	0.0	30.0	1.0	-
	PI Controller Proportional Gain. Higher values provide a greater change in the drive output frequency in response to small changes in the feedback signal. Too high a value can cause instability.				
P-42	PI Integral Time	0.0	30.0	1.0	s
	PI Controller Integral Time. Larger values provide a more damped response for systems where the overall process responds slowly.				
P-43	PI Operating Mode	0	3	0	-
	<p>0: Direct Operation. Use this mode if when the feedback signal drops, the motor speed should increase.</p> <p>1: Inverse Operation. Use this mode if when the feedback signal drops, the motor speed should decrease.</p> <p>2: Direct Operation, Wake at Full Speed. As setting 0, but on restart from Standby, PI Output is set to 100%.</p> <p>3: Inverse Operation, Wake at Full Speed. As setting 1, but on restart from Standby, PI Output is set to 100%.</p>				
P-44	PI Reference (Setpoint) Source	0	1	0	-
	<p>Selects the source for the PI Reference / Setpoint.</p> <p>0: Digital Preset. P-45 is used.</p> <p>1: Analog Input 1. Analog input 1 signal level, readable in P00-01 is used for the setpoint.</p>				
P-45	PI Digital Reference	0.0	100.0	0.0	%
	When P-44 = 0, this parameter sets the preset digital reference (setpoint) used for the PI Controller as a % of the feedback signal.				
P-46	PI Feedback Source	0	5	0	-
	<p>Selects the source of the feedback signal to be used by the PI controller.</p> <p>0: Analog Input 2 (Terminal 4) Signal level readable in P00-02.</p> <p>1: Analog Input 1 (Terminal 6) Signal level readable in P00-01.</p> <p>2: Motor Current Scaled as % of P-08.</p> <p>3: DC Bus Voltage Scaled 0 – 1000 Volts = 0 – 100%.</p> <p>4: Analog 1 – Analog 2 The value of Analog Input 2 is subtracted from Analog 1 to give a differential signal. The minimum value is 0.</p> <p>5: Largest (Analog 1, Analog 2) The larger of the two analog input values is always used for PI feedback.</p>				

Standby Mode & Wake Up (relevant parameters)

Par.	Description	Minimum	Maximum	Default	Units
P-48	Standby Mode Timer	0.0	25.0	0.0	s
	When standby mode is enabled by setting P-48 > 0.0, the drive will enter standby following a period of operating at minimum speed (P-02) for the time set in P-48. When in Standby Mode, the drive display shows Standby , and the output to the motor is disabled.				
P-49	PI Error Wake Up Level	0.0	100.0	5.0	%
	When the drive is operating in PI Control Mode (P-12 = 5 or 6), and Standby Mode is enabled (P-48 > 0.0), P-49 can be used to define the PI Error Level (E.g. difference between the setpoint and feedback) required before the drive restarts after entering Standby Mode. This allows the drive to ignore small feedback errors and remain in Standby mode until the feedback drops sufficiently.				

Serial Communication Configuration

Par.	Description	Minimum	Maximum	Default	Units
P-36	Serial Communications Configuration	See Below			
	Index 1 : Drive Address	1	63	1	-
	Index 2 : Comms Type & Baud Rate	9.6	1000	115.2	kbps
	Index 3 : Communication Loss Timeout	0	60000	300	ms
	This parameter has three sub settings used to configure the Modbus RTU Serial Communications. The Sub Parameters are:				
	Index 1 : Drive Address : Range : 0 – 63, default : 1				
	Index 2: Comms Type & Baud Rate: Selects the Baud Rate and network type for the internal RS485 communication port. For Modbus RTU: Baud rates 9.6, 19.2, 38.4, 57.6, 115.2 kbps are available. For CAN: Baud rates 125, 250, 500 & 1000 kbps are available.				
	Index 3: Communication Loss Timeout: Defines the time for which the drive will operate without receiving a valid command telegram after the drive has been enabled. This applies to Modbus RTU networks and Optibus networks (e.g. keypad control or Master Slave operation) only. CAN communication loss function is enabled via CAN objects 100Ch and 100Dh. Setting 0 disables the Watchdog timer. Setting a value of 30, 100, 1000, or 3000 defines the time limit in milliseconds for operation. A 't' suffix selects trip on loss of communication. An 'r' suffix means that the drive will coast stop (output immediately disabled) but will not trip.				

Current Limit (relevant parameters)

Par.	Description	Minimum	Maximum	Default	Units
P-54	Maximum Current Limit	0.0	175.0	150.0	%
	Defines the max current limit in vector control modes				

6.3.5. Advanced Functions**Autotune (relevant parameters)**

Par.	Description	Minimum	Maximum	Default	Units
P-52	Motor Parameter Autotune	0	1	0	-
	0: Disabled 1: Enabled. When enabled, the drive immediately measures required data from the motor for optimal operation. Ensure all motor related parameters are correctly set first before enabling this parameter. This parameter can be used to optimise the performance when P-51 = 0. Autotune is not required if P-51 = 1. For settings 2 – 5 of P-51, autotune MUST be carried out AFTER all other required motor settings are entered.				

Motor Control Methods

Optidrive E3 may be used with the following motor types:

- Asynchronous Induction Motors (IM)
- Synchronous Permanent Magnet AC Motors (PM)
- Brushless DC Motors (BLDC)
- Synchronous Reluctance Motors (SynRM)
- Line Start Permanent Magnet Motors (LSPM)

Each motor type requires the correct operating mode to be selected and the correct commissioning procedure to be followed as described in the following sections.

NOTE For more detailed information on the various motor types, please see the following pages.

Parameters

Par.	Description	Minimum	Maximum	Default	Units
P-07	Motor Rated Voltage / kE	0	250 / 500	230 / 400	V
	For Induction Motors, this parameter should be set to the rated (nameplate) voltage of the motor (Volts). For Permanent Magnet or Brushless DC Motors, it should be set to the Back EMF at rated speed.				
P-08	Motor Rated Current	Drive Rating Dependent			A
	This parameter should be set to the rated (nameplate) current of the motor. This parameter cannot be adjusted greater than the continuous current rating of the drive. When the motor nameplate value is entered, thermal overload protection is enabled.				
P-09	Motor Rated Frequency	10	500	50 (60)	Hz
	This parameter should be set to the rated (nameplate) frequency of the motor.				
P-51	Motor Control Mode	0	5	0	-
	0: Induction Motor, vector speed control 1: Induction Motor, V/F mode 2: PM motor, vector speed control 3: BLDC motor, vector speed control 4: Syn RM motor, vector speed control 5: LSPM motor, vector speed control				
P-52	Motor Parameter Auto-tune Enable	0	1	0	-
	This parameter can be used to optimise the performance when P-51 = 0. Autotune is not required if P-51 = 1. For settings 2 – 5 of P-51, autotune MUST be carried out AFTER all other required motor settings are entered. 0: Disabled 1: Enabled. When enabled, the drive immediately measures required data from the motor for optimal operation. Ensure all motor related parameters are correctly set first before enabling this parameter.				
P-53	Vector Speed Control P-gain	0.0	200.0	50.0	%
	Single Parameter for Vector speed loop tuning. Affects P & I terms simultaneously. Not active when P-51 = 1.				
P-55	Motor Stator Resistance	0.00	655.35	-	Ω
	Motor stator resistance in Ohms. Determined by Autotune, adjustment is not normally required.				
P-56	Motor Stator Inductance (d)	0.00	655.35	-	mH
	Determined by Autotune, adjustment is not normally required.				
P-57	Motor Stator Inductance (q)	0.00	655.35	-	mH
	Determined by Autotune, adjustment is not normally required.				

Overload Management (relevant parameters)

Par.	Description	Minimum	Maximum	Default	Units
P-60	Motor Overload Management	-	-	-	-
	Index 1: Thermal Overload Retention	0	1	0	1
	0: Disabled 1: Enabled. When enabled, the drive calculated motor overload protection information is retained after the mains power is removed from the drive.				
	Index 2: Thermal Overload Reaction	0	1	1	1
0: Trip. When the overload accumulator reaches the limit, the drive will trip on lt.trp to prevent damage to the motor. 1: No trip, current limit reduction. When the overload accumulator reaches 90%, the output current limit is internally reduced to 100% of P-08 in order to avoid an lt.trp. The current limit will return to the setting in P-54 when the overload accumulator reaches 10%.					

Ethernet Parameters

Par.	Description	Minimum	Maximum	Default	Units
P-61	Ethernet Service Option	0	1	0	-
	0: Disabled 1: Enabled				
P-62	Ethernet Service Timeout	0	60	0	mins
	0: Disabled >0: Timeout in minutes				
P-63	Modbus Mode Selection	0	1	0	-
	0: Standard ¹ 1: Advanced ²				

Switch Parameters

Par.	Description	Minimum	Maximum	Default	Units
P-64	IP66 DI1 Source	0	4	0	-
	Visible only on IP66 Switched Drives 0: Terminal 2 OR Switch Forward OR Switch Reverse 3: Terminal 2 AND (S-Forward OR Switch Reverse) 1: Terminal 2 Only 4: Terminal 2 AND Switch Forward 2: Terminal 2 AND Switch Forward OR Switch Reverse				
P-65	IP66 DI2 Source	0	2	0	-
	Visible only on IP66 Switched Drive 0: Terminal 3 OR Switch Reverse 1: Terminal 3 Only 2: Terminal 3 AND Switch Reverse				

6.4. Commissioning Various Motor Types

Asynchronous Induction Motors (IM) Vector Control

Optidrive E3 factory default parameters are intended for use with IM motors where the power rating of the motor is approximately the same or slightly less than the indicated power rating of the drive. In this case, it should be possible to operate the motor without any parameter adjustment at all for initial testing.

For optimum performance, the drive parameters should be adjusted to match the motor ratings. This will also ensure correct protection of the motor from damage due to overload.

The basic parameters that should be adjusted are:

- P-07 : Motor Rated Voltage (V)
- P-08 : Motor Rated Current (A)
- P-09 : Motor Rated Frequency (Hz)

In addition, it is also possible to set:

- P-10 : Motor Rated Speed (RPM)

When this parameter is adjusted, slip compensation is activated. Slip compensation attempts to compensate the motor speed relative to the load applied, such that when operating at a constant speed with different loads, the motor shaft speed should remain approximately the same.

To further improve the performance of the motor, the following additional steps can be followed:

- Carry out an Autotune.
 - This requires Advanced Parameter Access, $P-14 = P-37 + 100$ (Default : 201).
 - After the correct nameplate information is entered from the motor, the drive can additionally measure some electrical characteristics of the motor to further optimise the motor control to suit connected motor.
 - This is achieved by setting $P-52 = 1$.

The autotune will begin **IMMEDIATELY** following the setting of this parameter!

- The drive output will be enabled, and the motor shaft may move. It is important to ensure this is safe before carrying out the autotune.
- For IM motors, the autotune takes only a few seconds, and measures only the motor stator resistance. Parameter P-55 will be updated with the new value.
- Adjust the Low Frequency Torque Boost
 - IM motors require some additional voltage at low frequency to improve the low speed operation and torque.
 - By adjusting P-11, it is possible to optimise the low speed operation.
 - If P-11 is increased too far, excessive motor heating or over current trips may result.
- Speed regulation and response to load changes may be improved by adjusting P-11 Vector Gain to suit the motor and connected load.
 - Higher values will provide a more dynamic behaviour at the risk of instability.

Synchronous Permanent Magnet AC Motors (PM), BLDC Motors and LSPM Motors Suitable Motors

Optidrive E3 provides open loop control of permanent magnet AC motors including BLDC and LSPM type, intended to allow the use of high efficiency motors in simple applications. Both interior and exterior magnets type motors are supported.

Operation is permitted with motors meeting the following criteria:

- The motor Back EMF is ≥ 1 V / Hz.
 - **NOTE** Operation of motors with < 1 V/Hz Back EMF ratio may be possible with reduced speed range.
- Maximum motor frequency 360Hz.
- RMS Back EMF must not exceed the AC supply voltage during motor operation.
 - **Warning!** If the peak Back EMF exceeds 800V, the drive may be permanently damaged!

Commissioning Procedure

When operating with permanent magnet motors, the commissioning steps are as follows:

- Enter the motor Back EMF at Rated Frequency / Speed in parameter P-07.
 - This parameter must not be set to the rated motor voltage, but the actual Back EMF imposed by the motor magnets at the drive output terminals.
 - It is sometimes necessary to derive this information from a voltage constant and the rated operating speed, e.g.
 - If a motor has rated speed 2500RPM, back EMF constant 80V / 1000 RPM, $P-07 = (2500 * 80) / 1000 = 200V$.
 - Alternatively, obtain the value from the motor supplier, or by direct measurement using an oscilloscope.
- Enter the Motor Rated Current in P-08.
 - It is possible that excessive current levels may permanently damage the motor, therefore this parameter must be set correctly to ensure this cannot occur.
 - Additionally, this current level is used by the autotune to determine the correct inductance values.
- Enter the motor rated frequency in P-09.
- Optionally enter the motor rated speed in P-10.
- Enabled Advanced Parameter Access by setting $P-14 = P-37 + 100$ (Default : 201).
- Select the appropriate motor type in P-51
 - For PM motor control $P-51 = 2$
 - For BLDC motor control $P-51 = 3$
 - For LSPM motor control $P-51 = 5$

- Carry out an Autotune.
 - An Autotune **MUST** be carried out.
 - This is achieved by setting P-52 = 1.
 - The autotune will begin **IMMEDIATELY** following the setting of this parameter! The drive output will be enabled, and the motor shaft may move. It is important to ensure this is safe before carrying out the autotune.
 - For PM motors, the autotune measures the motor stator resistance and both Q and D axis inductance values. Parameters P-55, P-56 and P-57 will be updated following the measurements.
- It should now be possible to operate the motor.
- Low speed and starting of the motor may be further optimised by adjusting P-11.
 - In PM motor control mode, P-11 adjust the additional current injected into the motor at low frequency to help maintain the rotor alignment and ensure reliable starting.
- Speed regulation and response to load changes may be improved by adjusting P-53 Vector Gain to suit the motor and connected load.
 - Higher values will provide a more dynamic behaviour at the risk of instability.

Synchronous Reluctance Motors (SynRM)

Suitable Motors

Optidrive E3 provides open loop control of synchronous reluctance AC motors, intended to allow the use of high efficiency motors in simple applications.

Commissioning Procedure

When operating with synchronous reluctance motors, the commissioning steps are as follows:

- Enter the motor rated voltage in parameter P-07.
- Enter the Motor Rated Current in P-08.
- Enter the motor rated frequency in P-09.
- Optionally enter the motor rated speed in P-10.
- Enabled Advanced Parameter Access by setting P-14 = P-37 + 100 (Default : 201).
- Select SynRM motor control in by setting P-51 = 4.
- Carry out an Autotune.
 - For SynRM motor operation, an Autotune **MUST** be carried out.
 - This is achieved by setting P-52 = 1.
 - The autotune will begin **IMMEDIATELY** following the setting of this parameter!
 - The drive output will be enabled, and the motor shaft may move. It is important to ensure this is safe before carrying out the autotune.
 - For SynRM motors, the autotune measures the motor data required for correct operation.
- It should now be possible to operate the motor.
- Low speed and starting of the motor may be further optimised by adjusting P-11.
 - In SynRM motor control mode, P-11 adjust the additional current injected into the motor at low frequency to help maintain the rotor alignment and ensure reliable starting.
- Speed regulation and response to load changes may be improved by adjusting P-53 to suit the motor and connected load.
 - Higher values will provide a more dynamic behaviour at the risk of instability.

6.5. P-00 Read Only Status Parameters

Par.	Description	Explanation
P00-01	Analog Input 1 Value (%)	100% = max input voltage.
P00-02	Analog Input 2 Value (%)	100% = max input voltage.
P00-03	Speed Controller Reference (Hz / RPM)	Displayed in Hz if P-10 = 0, otherwise RPM.
P00-04	Digital Input Status	Drive digital input status.
P00-05	PI Output (%)	Displays value of the User PI output.
P00-06	DC Bus Voltage Ripple (V)	Measured DC bus ripple.
P00-07	Motor Voltage (V)	Value of RMS voltage applied to motor.
P00-08	DC Bus Voltage (V)	Internal DC bus voltage.
P00-09	Heatsink Temperature (°C)	Temperature of heatsink in °C.
P00-10	Run Time Since Date of Manuf. (Hours)	Not affected by resetting factory default parameters.
P00-11	Run Time Since Last Trip (1) (Hours)	Run-time clock stopped by drive disable (or trip), reset on next enable only if a trip occurred. Reset also on next enable after a drive power down.
P00-12	Run Time Since Last Trip (2) (Hours)	Run-time clock stopped by drive disable (or trip), reset on next enable only if a trip occurred (under-volts not considered a trip) – not reset by power down / power up cycling unless a trip occurred prior to power down.
P00-13	Trip Log	Displays most recent 4 trips with time stamp.
P00-14	Run Time Since Last Enable (Hours)	Run-time clock stopped on drive disable, value reset on next enable.
P00-15	Dc Bus Voltage Log (V)	8 most recent values prior to trip, 256ms sample time.
P00-16	Heatsink Temperature Log (°C)	8 most recent values prior to trip, 30s sample time.
P00-17	Motor Current Log (A)	8 most recent values prior to trip, 256ms sample time.
P00-18	DC Bus Voltage Ripple Log (V)	8 most recent values prior to trip, 22ms sample time.
P00-19	Internal Temperature Log (°C)	8 most recent values prior to trip, 30 s sample time.
P00-20	Internal Temperature (°C)	Actual internal ambient temperature in °C.
P00-21	CAN Process Data Input	Incoming process data (RX PDO1) for CAN: PI1, PI2, PI3, PI4.
P00-22	CAN Process Data Output	Outgoing process data (TX PDO1) for CAN: PO1, PO2, PO3, PO4.
P00-23	Accumulated Time with Heatsink > 85°C (Hours)	Total accumulated hours and minutes of operation above heatsink temp of 85°C.
P00-24	Accumulated Time with Internal Temp > 80°C (Hours)	Total accumulated hours and minutes of operation with drive internal ambient above 80°C.
P00-25	Estimated Rotor Speed (Hz)	In vector control modes, estimated rotor speed in Hz.
P00-26	kWh meter / MWh meter	Total number of kWh / MWh consumed by the drive.
P00-27	Cooling Fan Operating Lifetime (Hours)	Time displayed in hh:mm:ss. First value displays time in hrs, press up to display mm:ss.
P00-28	Software Version	Version number and checksum. "1" on LH side indicates I/O processor, "2" indicates power stage.
P00-29	Drive Type	Drive rating, drive type and software version codes.
P00-30	Drive Serial Number	Unique drive serial number.
P00-31	Motor Current Id / Iq	Displays the magnetising current (Id) and torque current (Iq). Press UP to show Iq.
P00-32	Actual Eff. Switching Frequency (kHz)	Actual switching frequency used by drive.
P00-33	O-I Fault Counter	These parameters log the number of times specific faults or errors occur, and are useful for diagnostic purposes.
P00-34	O-Volts Fault Counter	
P00-35	U-Volts Fault Counter	
P00-36	Heatsink O-Temp Counter	
P00-37	B O-I Fault Counter	
P00-38	Internal O-Temp Counter	
P00-39	Modbus RTU Fault Counter	
P00-40	CAN Fault Counter	
P00-41	I/O Comms Fault Counter	
P00-42	DSP Comms Fault Counter	
P00-43	Drive Total Life Time (Hours)	Total lifetime of drive with power applied.
P00-44	Phase U Current Offset & Ref	Internal value.
P00-45	Phase V Current Offset & Ref	Internal value.
P00-46	Phase W Current Offset & Ref	Internal value.
P00-47	Index 1: Fire Mode Total Active Time Index 2: Fire Mode Activation Count	Total activation time of Fire Mode. Displays the number of times Fire Mode has been activated.
P00-48	Scope Channel 1 & 2	Displays signals for scope channels 1 & 2.
P00-49	Scope Channel 3 & 4	Displays signals for scope channels 3 & 4.
P00-50	Bootloader and Motor Control	Internal value.

7. Analog and Digital Input Macro Configurations

7.1. Overview

Optidrive E3 uses a Macro approach to simplify the configuration of the Analog and Digital Inputs. There are two key parameters which determine the input functions and drive behaviour:

P-12 Selects the main drive control source and determines how the output frequency of the drive is primarily controlled.

P-15 Assigns the Macro function to the analog and digital inputs.

Additional parameters can then be used to further adapt the settings, e.g.

P-16 Used to select the format of the analog signal to be connected to analog input 1, e.g. 0 – 10 Volt, 4 – 20mA.

P-30 Determines whether the drive should automatically start following a power on if the Enable Input is present.

P-31 When Keypad Mode is selected, determines at what output frequency / speed the drive should start following the enable command, and also whether the keypad start key must be pressed or if the Enable input alone should start the drive.

P-47 Used to select the format of the analog signal to be connected to analog input 2, e.g. 0 – 10 Volt, 4 – 20mA.

7.2. Example Connection Diagrams

The diagrams below provide an overview of the functions of each terminal macro function, and a simplified connection diagram for each.

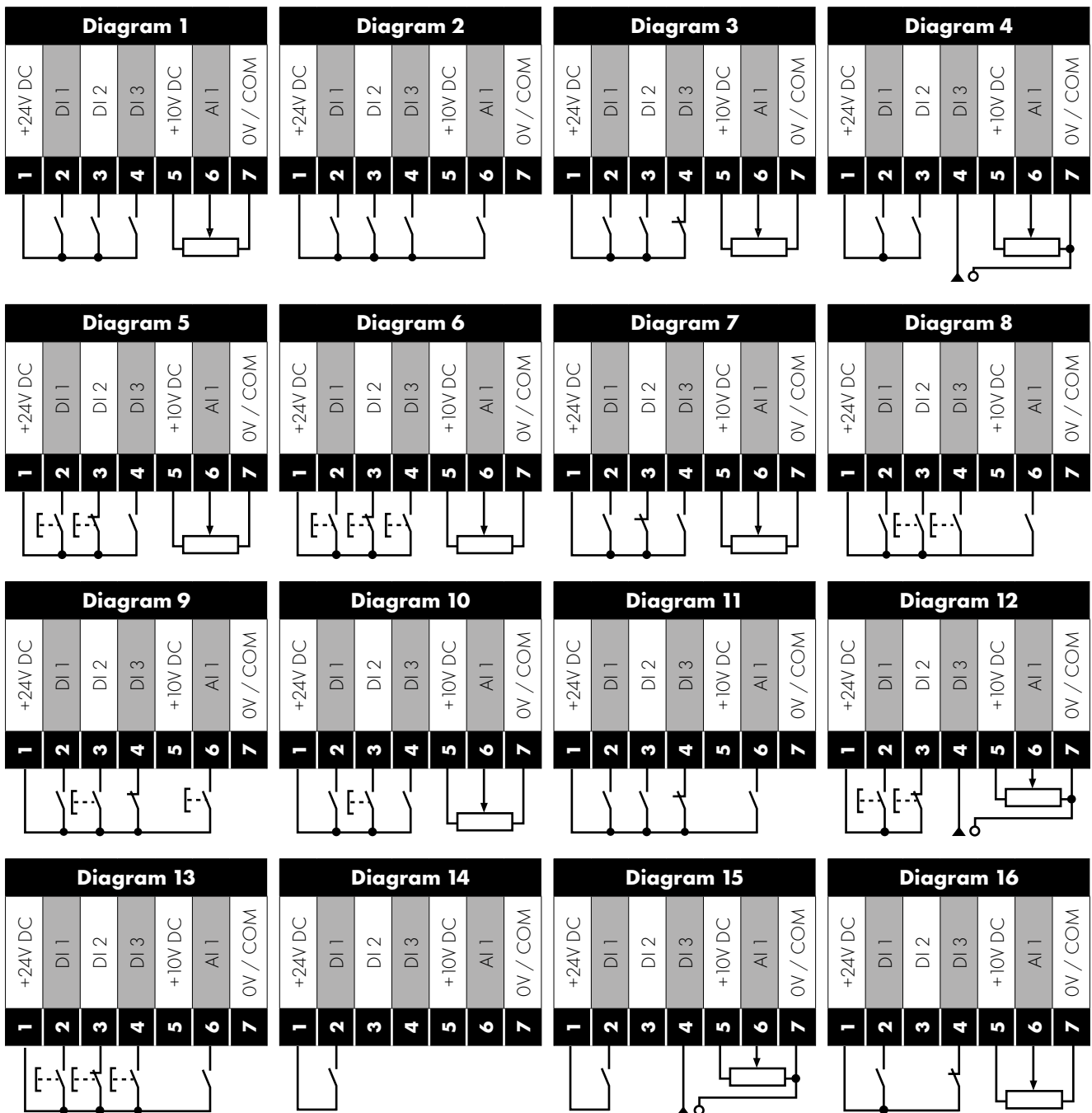

7.3. Macro Functions Guide Key

The table below should be used as a key on the following pages.

Function	Explanation
STOP	Latched Input, Open the contact to STOP the drive
RUN	Latched input, Close the contact to Start, the drive will operate as long as the input is maintained
FWD ↻	Latched Input, selects the direction of motor rotation FORWARD
REV ↻	Latched Input, selects the direction of motor rotation REVERSE
RUN FWD ↻	Latched Input, Close to Run in the FORWARD direction, Open to STOP
RUN REV ↻	Latched Input, Close to Run in the REVERSE direction, Open to STOP
ENABLE	Hardware Enable Input. In Keypad Mode, P-31 determines whether the drive immediately starts, or the keypad start key must be pressed. In other modes, this input must be present before the start command is applied via the fieldbus interface.
START ↑	Normally Open, Rising Edge, Close momentarily to START the drive (NC STOP Input must be maintained)
^ - START - ^	Simultaneously applying both inputs momentarily will START the drive (NC STOP Input must be maintained)
STOP ↓	Normally Closed, Falling Edge, Open momentarily to STOP the drive
START ↑ FWD ↻	Normally Open, Rising Edge, Close momentarily to START the drive in the forward direction (NC STOP Input must be maintained)
START ↑ REV ↻	Normally Open, Rising Edge, Close momentarily to START the drive in the reverse direction (NC STOP Input must be maintained)
^ - FAST STOP (P-24) - ^	When both inputs are momentarily active simultaneously, the drive stops using Fast Stop Ramp Time P-24
FAST STOP ↓ (P-24)	Normally Closed, Falling Edge, Open momentarily to FAST STOP the drive using Fast Stop Ramp Time P-24
E-TRIP	Normally Closed, External Trip input. When the input opens momentarily, the drive trips showing $E-Err$ or $Ptc-Err$ depending on P-47 setting
Fire Mode	Activates Fire Mode
Analog Input AI1	Analog Input 1, signal format selected using P-16
Analog Input AI2	Analog Input 2, signal format selected using P-47
AI1 REF	Analog Input 1 provides the speed reference
AI2 REF	Analog Input 2 provides the speed reference
P-xx REF	Speed reference from the selected preset speed
PR-REF	Preset speeds P-20 – P-23 are used for the speed reference, selected according to other digital input status
PI-REF	PI Control Speed Reference
PI FB	Analog Input used to provide a Feedback signal to the internal PI controller
KPD REF	Keypad Speed Reference selected
FB REF	Selected speed reference from Fieldbus (Modbus RTU / CAN Open / Master depending on P-12 setting)
(NO)	Input is Normally Open, Close momentarily to activate the function
(NC)	Input is Normally Closed, Open momentarily to activate the function
INC SPD ↑	Normally Open, Rising Edge, Close momentarily to increase the motor speed by value in P-20
DEC SPD ↓	Normally Open, Rising Edge, Close momentarily to decrease the motor speed by value in P-20

7.4. Macro Functions – Terminal Mode (P-12 = 0)

P-15	DI1		DI2		DI3 / AI2		DI4 / AI1		Diagram	
	0	1	0	1	0	1	0	1		
0	STOP	RUN	FWD ↻	REV ↻	AI1 REF	P-20 REF	Analog Input AI1		1	
1	STOP	RUN	AI1 REF	PR-REF	P-20	P-21	Analog Input AI1		1	
2	STOP	RUN	DI2	DI3	PR		P-20 - P-23	P-01	2	
			0	0	P-20					
			1	0	P-21					
			0	1	P-22					
			1	1	P-23					
3	STOP	RUN	AI1	P-20 REF	E-TRIP	OK	Analog Input AI1		3	
4	STOP	RUN	AI1	AI2	Analog Input AI2		Analog Input AI1		4	
5	STOP	RUN FWD ↻	STOP	RUN REV ↻	AI1	P-20 REF	Analog Input AI1		1	
	^-----FAST STOP (P-24)-----^									
6	STOP	RUN	FWD ↻	REV ↻	E-TRIP	OK	Analog Input AI1		3	
7	STOP	RUN FWD ↻	STOP	RUN REV ↻	E-TRIP	OK	Analog Input AI1		3	
	^-----FAST STOP (P-24)-----^									
8	STOP	RUN	FWD ↻	REV	DI3	DI4	PR		2	
					0	0	P-20			
					1	0	P-21			
					0	1	P-22			
			1	1	P-23					
9	STOP	START FWD ↻	STOP	START REV ↻	DI3	DI4	PR		2	
					0	0	P-20			
					1	0	P-21			
					0	1	P-22			
			1	1	P-23					
10	(NO)	START ↑	STOP	(NC)	AI1 REF	P-20 REF	Analog Input AI1		5	
11	(NO)	START ↑ FWD ↻	STOP	(NC)	(NO)	START ↑ REV ↻	Analog Input AI1		6	
							^-----FAST STOP (P-24)-----^			
12	STOP	RUN	FAST STOP (P-24)	OK	AI1 REF	P-20 REF	Analog Input AI1		7	
13	(NO)	START FWD ↻	STOP	(NC)	(NO)	START REV ↻	KPD REF	P-20 REF	13	
										^-----FAST STOP (P-24)-----^
14	STOP	RUN	DI2		E-TRIP	OK	DI2	DI4	PR	11
			0	0			P-20			
			1	0			P-21			
			0	1			P-22			
			1	1	P-23					
15	STOP	RUN	P-23 REF	AI1	Fire Mode		Analog Input AI1		1	
16	STOP	RUN	P-23 REF	P-21 REF	Fire Mode		FWD	REV	2	
17	STOP	RUN	DI2		Fire Mode		DI2	DI4	PR	2
			0	0	P-20					
			1	0	P-21					
			0	1	P-22					
			1	1	P-23					
18	STOP	RUN	FWD ↻	REV ↻	Fire Mode		Analog Input AI1		1	
19	STOP	RUN	AI1 REF	PR1 REF	No Function	Fire Mode	AI1		1	
NOTE	When P-15 = 19, P-30 Index 2 and Index 3 have no effect. When the fire mode input is on, the drive will run regardless of whether the run input is present. Speed reference in Fire Mode is always Preset Speed 4, P-23.									

7.5. Macro Functions - Keypad Mode (P-12 = 1 or 2)

P-15	DI1		DI2		DI3 / AI2		DI4 / AI1		Diagram
	0	1	0	1	0	1	0	1	
0	STOP	ENABLE	-	INC SPD ↑	-	DEC SPD ↓	FWD ↻	REV ↻	8
^-----START-----^									
1	STOP	ENABLE	PI Speed Reference						2
2	STOP	ENABLE	-	INC SPD ↑	-	DEC SPD ↓	KPD REF	P-20 REF	8
^-----START-----^									
3	STOP	ENABLE	-	INC SPD ↑	E-TRIP	OK	-	DEC SPD ↓	9
^-----START-----^									
4	STOP	ENABLE	-	INC SPD ↑	KPD REF	AI1 REF	AI1		10
5	STOP	ENABLE	FWD ↻	REV ↻	KPD REF	AI1 REF	AI1		1
6	STOP	ENABLE	FWD ↻	REV ↻	E-TRIP	OK	KPD REF	P-20 REF	11
7	STOP	RUN FWD	STOP	RUN REV ↻	E-TRIP	OK	KPD REF	P-20 REF	11
^-----FAST STOP (P-24)-----^									
8	STOP	RUN FWD ↻	STOP	RUN REV ↻	KPD REF	AI1 REF	AI1		1
14	STOP	ENABLE	-	INC SPD ↑	E-TRIP	OK	-	DEC SPD ↓	
15	STOP	ENABLE	PR REF	KPD REF	Fire Mode		P-23	P-21	2
16	STOP	ENABLE	P-23 REF	KPD REF	Fire Mode		FWD ↻	REV ↻	2
17	STOP	ENABLE	KPD REF	P-23 REF	Fire Mode		FWD ↻	REV ↻	2
18	STOP	ENABLE	AI1 REF	KPD REF	Fire Mode		AI1		1
19	STOP	RUN	KPD REF	PR1 REF	No Function	Fire Mode	AI1		1
9, 10, 11, 12, 13 = Behavior as per setting 0									
NOTE	<p>When P15=4 in keypad mode, DI2 & DI4 are edge triggered. Digital pot speed will be increased or decreased once for each rising edge. The step of each speed change is defined by the absolute value of Pre-set Speed 1 (P-20).</p> <p>Speed change only happens during normal running condition (no stop command etc.). Digital pot will be adjusted between minimum speed (P-02) and maximum speed (P-01).</p> <p>When P-15 = 19, P-30 Index 2 and Index 3 have no effect. When the fire mode input is on, the drive will run regardless of whether the run input is present. Speed reference in Fire Mode is always Preset Speed 4, P-23.</p>								

7.6. Macro Functions - Fieldbus Control Mode (P-12 = 3, 4, 7, 8 or 9)

P-15	DI1		DI2		DI3 / AI2		DI4 / AI1		Diagram
	0	1	0	1	0	1	0	1	
0	STOP	ENABLE	FB REF (Fieldbus Speed Reference, Modbus RTU / CAN / Master-Slave defined by P-12)						14
1	STOP	ENABLE	PI Speed Reference						15
3	STOP	ENABLE	FB REF	P-20 REF	E-TRIP	OK	Analog Input AI1		3
5	STOP	ENABLE	FB REF	PR REF	P-20	P-21	Analog Input AI1		1
^----START (P-12 = 3 or 4 Only)----^									
6	STOP	ENABLE	FB REF	AI1 REF	E-TRIP	OK	Analog Input AI1		3
^----START (P-12 = 3 or 4 Only)----^									
7	STOP	ENABLE	FB REF	KPD REF	E-TRIP	OK	Analog Input AI1		3
^----START (P-12 = 3 or 4 Only)----^									
14	STOP	ENABLE	-	-	E-TRIP	OK	Analog Input AI1		16
15	STOP	ENABLE	PR REF	FB REF	Fire Mode		P-23	P-21	2
16	STOP	ENABLE	P-23 REF	FB REF	Fire Mode		Analog Input AI1		1
17	STOP	ENABLE	FB REF	P-23 REF	Fire Mode		Analog Input AI1		1
18	STOP	ENABLE	AI1 REF	FB REF	Fire Mode		Analog Input AI1		1
2, 4, 8, 9, 10, 11, 12, 13, 19 = Behavior as per setting 0									

7.7. Macro Functions - User PI Control Mode (P-12 = 5 or 6)

P-15	DI1		DI2		DI3 / AI2		DI4 / AI1		Diagram
	0	1	0	1	0	1	0	1	
0	STOP	RUN	PI REF	P-20 REF	AI2		AI1		4
1	STOP	RUN	PI REF	AI1 REF	AI2 (PI FB)		AI1		4
3, 7	STOP	RUN	PI REF	P-20	E-TRIP	OK	AI1 (PI FB)		3
4	(NO)	START	(NC)	STOP	AI2 (PI FB)		AI1		12
5	(NO)	START	(NC)	STOP	PI REF	P-20 REF	AI1 (PI FB)		5
6	(NO)	START	(NC)	STOP	E-TRIP	OK	AI1 (PI FB)		
8	STOP	RUN	FWD ↻	REV ↻	AI2 (PI FB)		AI1		4
9	STOP	RUN	FWD ↻	REV ↻	PI REF	PR1 REF	AI1		1
14	STOP	RUN	-	-	E-TRIP	OK	AI1 (PI FB)		16
15	STOP	RUN	P-23 REF	PI REF	Fire Mode		AI1 (PI FB)		1
16	STOP	RUN	P-23 REF	P-21 REF	Fire Mode		AI1 (PI FB)		1
17	STOP	RUN	FWD ↻	REV ↻	E-TRIP	-	AI1		3
18	STOP	RUN	AI1 REF	PI REF	Fire Mode		AI1 (PI FB)		1
2, 9, 10, 11, 12, 13, 19 = Behavior as per setting 0									
NOTE	P1 Setpoint source is selected by P-44 (default is fixed value in P-45, AI 1 may also be selected). P1 Feedback source is selected by P-46 (default is AI 2, other options may be selected).								

8. Modbus RTU Communications

8.1. Introduction

The Optidrive E3 can be connected to a Modbus RTU network via the RJ45 connector on the front of the drive.

8.2. Modbus RTU Specification

Protocol	Modbus RTU
Error check	CRC
Baud rate	9600bps, 19200bps, 38400bps, 57600bps, 115200bps (default)
Data format	1 start bit, 8 data bits, 1 stop bits, no parity
Physical signal	RS 485 (2-wire)
User interface	RJ45
Supported Function Codes	03 Read Multiple Holding Registers 06 Write Single Holding Register 16 Write Multiple Holding Registers (Supported for registers 1 – 4 only)

8.3. RJ45 Connector Configuration

For full MODBUS RTU register map information please refer to your Invertek Drives Sales Partner. Local contacts can be found by visiting our website:

www.invertekdrives.com

When using MODBUS control the Analog and Digital Inputs can be configured as shown in section 7.6. Macro Functions - Fieldbus Control Mode (P-12 = 3, 4, 7, 8 or 9).

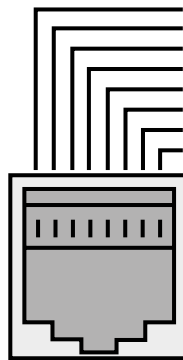

1	CAN -
2	CAN +
3	0 Volts
4	-RS485 (PC)
5	+RS485 (PC)
6	+24 Volt
7	-RS485 (Modbus RTU)
8	+RS485 (Modbus RTU)

Warning: This is not an Ethernet connection. Do not connect directly to an Ethernet port.

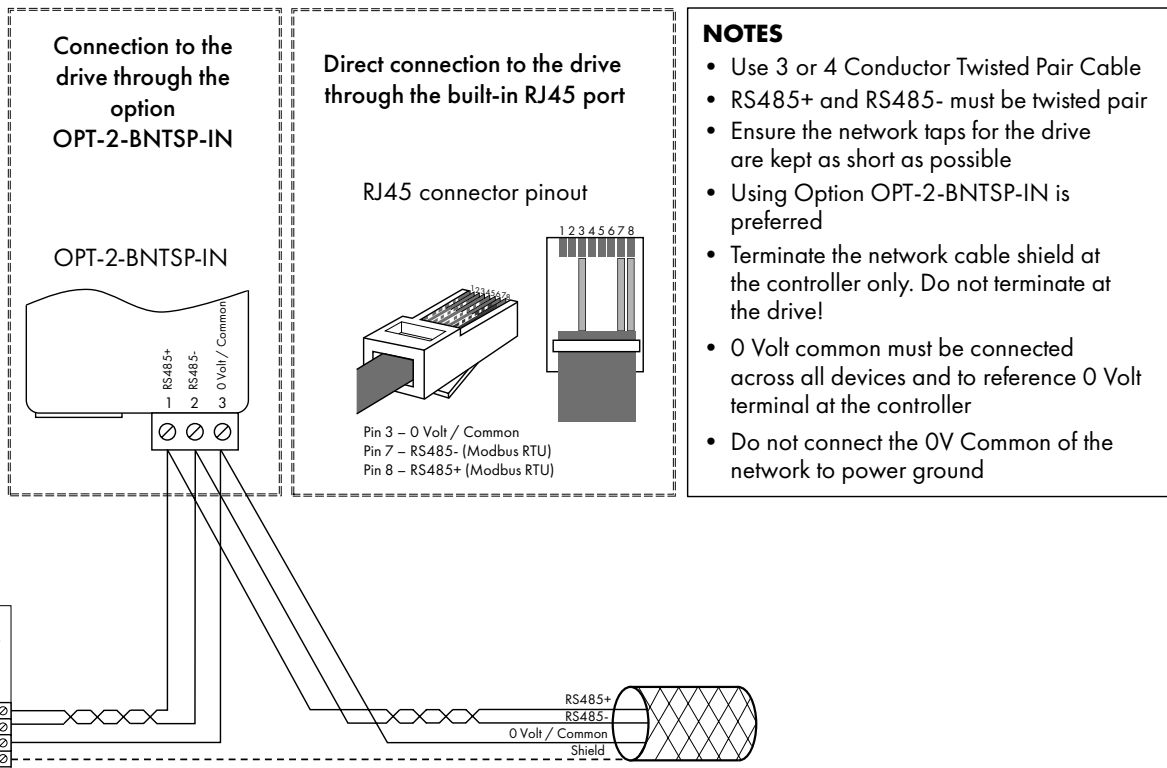

NOTES

- Use 3 or 4 Conductor Twisted Pair Cable
- RS485+ and RS485- must be twisted pair
- Ensure the network taps for the drive are kept as short as possible
- Using Option OPT-2-BNTSP-IN is preferred
- Terminate the network cable shield at the controller only. Do not terminate at the drive!
- 0 Volt common must be connected across all devices and to reference 0 Volt terminal at the controller
- Do not connect the 0V Common of the network to power ground

8.4. Modbus Register Map

Register Number	Par.	Type	Supported Function Codes			Function		Range	Explanation
			03	06	16	Low Byte	High Byte		
1	-	R/W	✓	✓	✓	Drive Control Command		0..3	16 Bit Word. Bit 0: Low = Stop, High = Run Enable Bit 1: Low = Decel Ramp 1 (P-04), High = Decel Ramp 2 (P-24) Bit 2: Low = No Function, High = Fault Reset Bit 3: Low = No Function, High = Coast Stop Request Bit 8: Relay control, 0 = Open, 1 = Close Bit 9 : DO Control, 1 = Off, 0 = On
2	-	R/W	✓	✓	✓	Modbus Speed reference setpoint		0..5000	Setpoint frequency x10, e.g. 100 = 10.0Hz
4	-	R/W	✓	✓	✓	Acceleration and Deceleration Time		0..60000	Ramp time in seconds x 100, e.g. 250 = 2.5 seconds
6	-	R	✓			Drive status	Error code		Low Byte = Drive Error Code, see section 11.1. Fault Code Messages High Byte = Drive Status as follows: 0: Drive Running 1: Drive Tripped 5: Standby Mode 6: Drive Ready
7		R	✓			Output Motor Frequency		0..20000	Output frequency in Hz x 10, e.g. 100 = 10.0Hz
8		R	✓			Output Motor Current		0..480	Output Motor Current in Amps x10, e.g. 10 = 1.0 Amps
11	-	R	✓			Digital input status		0..15	Indicates the status of the 4 digital inputs Lowest Bit = 1 Input 1
20	P00-01	R	✓			Analog Input 1 value		0..1000	Analog input % of full scale x 10, e.g. 1000 = 100%
21	P00-02	R	✓			Analog Input 2 value		0..1000	Analog input % of full scale x 10, e.g. 1000 = 100%
22	P00-03	R	✓			Speed Reference Value		0..1000	Displays the setpoint frequency x10, e.g. 100 = 10.0Hz
23	P00-08	R	✓			DC bus voltage		0..1000	DC Bus Voltage in Volts
24	P00-09	R	✓			Drive temperature		0..100	Drive heatsink temperature in °C
2001	-	R	✓			Status Word 2			See below
2002	-	R	✓			Motor Output Speed			Speed in Hz with one decimal place
2003	-	R	✓			Motor Output Current			Current in A with one decimal place
2004	-	R	✓			Motor Output Power			Power in kW with one decimal place
2005	-	R	✓			IO Status Word			See below
2006	-	R	✓			Motor Output Torque			0.0% to +/- 200.0%
2007	P00-08	R	✓			DC Bus Voltage			0 – 1000V
2008	P00-09	R	✓			Heatsink Temperature			Temperature in °C
2009	P00-01	R	✓			Analog Input 1			0 ~ 4096 (12bits)
2010	P00-02	R	✓			Analog Input 2			0 ~ 4096 (12bits)
2011	-	R	✓			Analog Output			0.0 to 100.0%
2012	P00-05	R	✓			PI Output			0.0 to 100.0%
2013	P00-20	R	✓			Internal Temperature			Temperature in °C
2014	P00-07	R	✓			Motor Output Voltage			0 – 500V
2015	-	R	✓			IP66 Pot Input value			0 ~ 4096 (12bits)
2016	-	R	✓			Trip Code			See user guide for code definition

All user configurable parameters are accessible as Holding Registers, and can be Read from or Written to using the appropriate Modbus command. The Register number for each parameter P-04 to P-60 is defined as 128 + Parameter number, e.g. for parameter P-15, the register number is 128 + 15 = 143. Internal scaling is used on some parameters, for further details please contact your Invertek Drives Sales Partner.

8.4.1. Register 2001 definition – New Status Word

Bit	Definition	Description
0	Ready	This bit is set if no trip and no mains loss, plus hardware enabled
1	Running	This bit is set when drive is running
2	Tripped	This bit is set when drive is under trip condition
3	Standby	This bit is set when drive is in standby mode
4	Fire Mode	This bit is set if fire mode is active
5	Reserved	Read as 0
6	Speed Set-point Reached (At Speed)	This bit is set when drive is enabled and reaches speed set point
7	Below Minimum Speed	This bit is set when drive is enabled and speed less than P-02
8	Overload	This bit is set if motor current > P-08
9	Mains Loss	This bit is set if mains loss condition happens
10	Heatsink > 85°C	This bit is set if drive heatsink temperature over 85°C
11	Control Board > 80°C	This bit is set if control PCB temperature over 80°C
12	Switching Frequency Reduction	This bit is set if PWM switching frequency foldback is active
13	Reverse Rotation	This bit is set when motor is in reverse rotation (negative speed)
14	Reserved	Read as 0
15	Live Toggle Bit	This bit will toggle each time this register is read

8.4.2. Register 2005 definition – IO Status Word

Bit	Definition	Description
0	D11 Status	This bit is set when digital input 1 is closed
1	D12 Status	This bit is set when digital input 2 is closed
2	D13 Status	This bit is set when digital input 3 (AI-2) is closed
3	D14 Status	This bit is set when digital input 4 (AI-1) is closed
4, 5	Reserved	Read as 0
6	IP66 Switch FWD	This bit is set when IP66 FWD switch is closed
7	IP66 Switch REV	This bit is set when IP66 REV switch is closed
8	Digital Output Status	This bit is set when digital output is active(24V) or Analog output > 0
9	Relay Output Status	This bit is set when user relay is closed
10, 11	Reserved	Read as 0
12	Analog Input 1 Signal Lost (4-20mA)	This bit is set when analog input 1 signal loss happens (4..20mA)
13	Analog Input 2 signal Lost (4-20mA)	This bit is set when analog input 2 signal loss happens (4..20mA)
14	Reserved	Read as 0
15	IP66 Pot Input > 50%	This bit is set when IP66 integrated pot input value > 50%

9. CAN Communication

9.1. CAN Communication

The CAN communication profile in the Optidrive E3 is implemented according to the specification DS301 version 4.02 of CAN in automation (www.can-cia.de). Specific device profiles such as DS402 are not supported.

The CAN communication function is enabled by default after power up. However in order to use any control functions through CAN, the following setting is required: P-12 = 7 or 8.

The CAN communication baud rate can be set by using parameter P-36 (Index 2). Available baud rates are: 125kbps, 250kbps, 500kbps, 1Mbps. (with default setting as 500kbps).

The Node ID is set up through drive address parameter P-36 (Index 1) with the default value of 1.

The tables below show the Index and Sub Index required to address each parameter. All User Adjustable parameters are accessible by CAN, except those that would directly affect the communications.

All parameter values can be read from the drive and written to, depending on the operating mode of the drive – some parameters may not be changed whilst the drive is enabled.

Optidrive E3 provides the following default COB-ID and functions:

Type	COB-ID	Function
NMT	000h	Network management.
Sync	080h	Synchronous message. COB-ID can be configured to other value.
Emergency	080h + Node address	Emergency message.
PDO 1 (TX)	180h + Node address	Process data object. PDO1 is pre-mapped and enabled by default. COB-ID can be configured to other value. PDO2 is pre-mapped and disabled by default. Transmission mode, COB-ID and mapping can be configured.
PDO 1 (RX)	200h + Node address	
PDO 2 (TX)	280h + Node address	
PDO 2 (RX)	300h + Node address	
SDO (TX)	580h + Node address	SDO channel can be used for drive parameter access.
SDO (RX)	600h + Node address	
Error Control	700h + Node address	Guarding and Heartbeat function are supported. COB-ID can be configured to other value.

NOTE

- The Optidrive E3 SDO channel only supports expedited transmission.
- The Optidrive E3 can only support up to 2 Process Data Objects (PDO). All PDOs are pre-mapped; however PDO2 is disabled by default. The table below gives the default PDO mapping information.
- Customer configuration (mapping) will NOT be saved during power down. This means that the CANopen configuration will restore to its default condition each time the drive is powered up.

9.1.1. PDO Default Mapping

	Objects No.	Mapped Object	Length	Mapped Function	Transmission Type
RX PDO 1	1	2000h	Unsigned 16	Control command register*	254 Valid immediately
	2	2001h	Integer 16	Speed reference	
	3	2003h	Unsigned 16	User ramp reference	
	4	0006h	Unsigned 16	Dummy	
TX PDO 1	1	200Ah	Unsigned 16	Drive status register	254 Send after receiving RX PDO 1
	2	200Bh	Integer 16	Motor speed Hz	
	3	200Dh	Unsigned 16	Motor current	
	4	2010h	Integer 16	Drive temperature	

	Objects No.	Mapped Object	Length	Mapped Function	Transmission Type
RX PDO2	1	0006h	Unsigned 16	Dummy	254
	2	0006h	Unsigned 16	Dummy	
	3	0006h	Unsigned 16	Dummy	
	4	0006h	Unsigned 16	Dummy	
TX PDO2	1	2011h	Unsigned 16	DC bus voltage	254
	2	2012h	Unsigned 16	Digital input status	
	3	2013h	Integer 16	Analog input 1 (%)	
	4	2014h	Integer 16	Analog input 2 (%)	

* Drive control can only be achieved when P-12=7 or 8 provided that P-31 = 0, 1, 4 or 5.

9.1.2. PDO transmission type

Various transmission modes can be selected for each PDO. For RX PDO, the following modes are supported:

Transmission Type	Mode	Description
0 – 240	Synchronous	The received data will be transferred to the drive active control register when the next sync message is received.
254, 255	Asynchronous	The received data will be transferred to the drive active control register immediately without delay.

For TX PDO, the following modes are supported:

Transmission Type	Mode	Description
0	Acyclic synchronous	TX PDO will only be sent out if the PDO data has changed and PDO will be transmitted on reception of SYNC object.
1-240	Cyclic synchronous	TX PDO will be transmitted synchronously and cyclically. The transmission type indicates the number of SYNC object that are.
254	Asynchronous	TX PDO will only be transferred once corresponding RX PDO has been received.
255	Asynchronous	TX PDO will only be transferred anytime if PDO data value has changed.

9.1.3. CAN Open Specific Object Table

Index	Sub Index	Function	Access	Type	PDO Map	Default Value
1000h	0	Device Type	R	U32	N	0
1001h	0	Error Register	R	U8	N	0
1002h	0	Manufacturer Status Register	R	U16	N	0
1005h	0	COB-ID Sync	RW	U32	N	00000080h
1008h	0	Manufacturer Device Name	R	String	N	ODE3
1009h	0	Manufacturer Hardware Version	R	String	N	x.xx
100Ah	0	Manufacturer Software Version	R	String	N	x.xx
100Ch	0	Guard Time (1 ms)	RW	U16	N	0
100Dh	0	Life Time Factor	RW	U8	N	0
1014h	0	COB-ID EMCY	RW	U32	N	00000080h+Node ID
1015h	0	Inhibit Time Emergency (100µs)	RW	U16	N	0
1017h	0	Producer Heartbeat Time (1 ms)	RW	U16	N	0
1018h	0	Identity Object No. Of entries	R	U8	N	4
	1	Vendor ID	R	U32	N	0x0000031A
	2	Product Code	R	U32	N	Drive Dependent
	3	Revision Number	R	U32	N	x.xx
	4	Serial Number	R	U32	N	Drive Dependent

Index	Sub Index	Function	Access	Type	PDO Map	Default Value
1200h	0	SDO Parameter No. Of entries	R	U8	N	2
	1	COB-ID Client -> Server (RX)	R	U32	N	00000600h+Node ID
	2	COB-ID Server -> Client (TX)	R	U32	N	00000580h+Node ID
1400h	0	RX PDO1 comms param. no. of entries	R	U8	N	2
	1	RX PDO1 COB-ID	RW	U32	N	40000200h+Node ID
	2	RX PDO transmission type	RW	U32	N	254
1401h	0	RX PDO2 comms param. no. of entries	R	U8	N	2
	1	RX PDO2 COB-ID	RW	U32	N	C0000300h+Node ID
	2	RX PDO2 transmission type	RW	U8	N	0
1600h	0	RX PDO1 1 mapping / no. of entries	RW	U8	N	4
	1	RX PDO1 1st mapped object	RW	U32	N	20000010h
	2	RX PDO1 2nd mapped object	RW	U32	N	20010010h
	3	RX PDO1 3rd mapped object	RW	U32	N	20030010h
	4	RX PDO1 4th mapped object	RW	U32	N	00060010h
1601h	0	RX PDO2 1 mapping / no. of entries	RW	U8	N	4
	1	RX PDO2 1st mapped object	RW	U32	N	00060010h
	2	RX PDO2 2nd mapped object	RW	U32	N	00060010h
	3	RX PDO2 3rd mapped object	RW	U32	N	00060010h
	4	RX PDO2 4th mapped object	RW	U32	N	00060010h
1800h	0	TX PDO1 comms parameter number of entries	R	U8	N	3
	1	TX PDO1 COB-ID	RW	U32	N	40000180h+Node ID
	2	TX PDO1 transmission type	RW	U8	N	254
	3	TX PDO1 Inhibit time (100µs)	RW	U16	N	0
1801h	0	TX PDO2 comms param no. of entries	R	U8	N	3
	1	TX PDO2 COB-ID	RW	U32	N	C0000280h+Node ID
	2	TX PDO2 transmission type	RW	U8	N	0
	3	TX PDO2 Inhibit time (100µs)	RW	U16	N	0
1A00h	0	TX PDO1 mapping / no. of entries	RW	U8	N	4
	1	TX PDO1 1st mapped object	RW	U32	N	200A0010h
	2	TX PDO1 2nd mapped object	RW	U32	N	200B0010h
	3	TX PDO1 3rd mapped object	RW	U32	N	200D0010h
	4	TX PDO1 4th mapped object	RW	U32	N	20100010h
1A01h	0	TX PDO2 mapping / no. of entries	RW	U8	N	4
	1	TX PDO2 1st mapped object	RW	U32	N	20110010h
	2	TX PDO2 2nd mapped object	RW	U32	N	20120010h
	3	TX PDO2 3rd mapped object	RW	U32	N	20130010h
		TX PDO2 4th mapped object	RW	U32	N	20140010h

9.2. Additional Information Relating to CAN or Modbus or Both

9.2.1 Drive Control Word Format

15	14	13	12	11	10	9	8	7	6	5	4	3	2	1	0
High byte								Low byte							

Bit 0: Run/Stop command: Set to 1 to enable the drive. Set to 0 to stop the drive.

Bit 1: Fast stop request. Set to 1 to enable drive to stop with 2nd deceleration ramp.

Bit 2: Reset request. Set to 1 in order to reset the drive if drive is under trip condition.

User must clear this bit when drive is under normal condition to prevent un-expected reset.

Bit 3: Coast stop request. Set to 1 to issue a coast stop command.

For normal operation, Bit 3 has the highest priority, bit 0 has the lowest priority (bit 3>bit 1>bit 0). For example if user set command as 0x0009, drive will do a coast stop rather than run. For normal run/start, just set this register to 1.

NOTE Start/stop (bit 0), fast stop (bit 1) and coast stop (bit 3) only works if P-31 = 0 or 1. Otherwise, start/stop function is controlled by drive control terminals. Reset function (bit 2) works all the time as long as drive is operated under Modbus control mode (P-12=3 or 4).

9.2.2 Speed Reference Format

Speed reference value is transferred with one decimal place (200 = 20.0Hz). The maximum speed reference value is limited by P-01. Either register 2 or register 5 can be used for speed reference control, however only one reference should be used in any control system, otherwise unexpected behaviour can result.

9.2.3 Acceleration / Deceleration Ramp Time

Active only when P-12 = 4, this register specifies the drive acceleration and deceleration ramp time. The same value is applied simultaneously to the acceleration and deceleration ramp times. The value has two decimal places, e.g. 500 = 5.00 seconds.

9.2.4 Drive status and error code Word

High byte gives drive error code. (Valid when the drive is tripped, see 11.1. Fault Code Messages for further details)

Low byte gives drive status information as follows:

Bit 0: 0 = Drive Stopped, 1 = Drive Running

Bit 1: 0 = OK, 1 = Drive Tripped

Bit 5: 0 = OK, 1 = In Standby Mode

Bit 6: 0 = Not Ready, 1 = Drive Ready to Run (not tripped, hardware enabled and no mains loss condition)

10. Technical Data

10.1. Environmental

Operational ambient temperature range	:	-20 ... 40°C (frost and condensation free)
Storage ambient temperature range	:	-40 ... 60°C
Maximum altitude	:	2000m. Derate above 1000m: 2.5% / 100m
Maximum humidity	:	95%, non-condensing
Environmental Conditions	:	IP66 Optidrive E3 products are designed to operate in 3S3/3C3 environments in accordance with IEC 60721-3-3.

10.2. Rating Tables

Frame Size	kW	HP	Input Current	Fuse / MCB (Type B)		Maximum Cable Size		Output Current	Recommended Brake Resistance
				Non UL	UL	mm	AWG		
110 - 115 (+ / - 10%) V 1 Phase Input, 230V 3 Phase Output (Voltage Doubler)									
1	0.37	0.5	7.8	10	10	8	8	2.3	-
1	0.75	1	15.8	25	20	8	8	4.3	-
2	1.1	1.5	21.9	32	30	8	8	5.8	100
200 - 240 (+ / - 10%) V 1 Phase Input, 3 Phase Output									
1	0.37	0.5	3.7	10	6	8	8	2.3	-
1	0.75	1	7.5	10	10	8	8	4.3	-
1	1.5	2	12.9	16	17.5	8	8	7	-
2	1.5	2	12.9	16	17.5	8	8	7	100
2	2.2	3	19.2	25	25	8	8	10.5	50
3	4	5	29.2	40	40	8	8	15.3	25
200 - 240 (+ / - 10%) V 3 Phase Input, 3 Phase Output									
1	0.37	0.5	3.4	6	6	8	8	2.3	-
1	0.75	1	5.6	10	10	8	8	4.3	-
1	1.5	2	9.5	16	15	8	8	7	-
2	1.5	2	8.9	16	15	8	8	7	100
2	2.2	3	12.1	16	17.5	8	8	10.5	50
3	4	5	20.9	32	30	8	8	18	25
3	5.5	7.5	26.4	40	35	8	8	24	20
4	7.5	10	33.3	40	45	16	5	30	15
4	11	15	50.1	63	70	16	5	46	10
380 - 480 (+ / - 10%) V 3 Phase Input, 3 Phase Output									
1	0.75	1	3.5	6	6	8	8	2.2	-
1	1.5	2	5.6	10	10	8	8	4.1	-
2	1.5	2	5.6	10	10	8	8	4.1	250
2	2.2	3	7.5	16	10	8	8	5.8	200
2	4	5	11.5	16	15	8	8	9.5	120
3	5.5	7.5	17.2	25	25	8	8	14	100
3	7.5	10	21.2	32	30	8	8	18	80
3	11	15	27.5	40	35	8	8	24	50
4	15	20	34.2	40	45	16	5	30	30
4	18.5	25	44.1	50	60	16	5	39	22
4	22	30	51.9	63	70	16	5	46	22

NOTE Cable sizes shown are the maximum possible that may be connected to the drive. Cables should be selected according to local wiring codes or regulations at the point of installation.

10.3. Single Phase Operation of Three Phase Drives

All drive models except size 4 are intended for operation from three phase mains power supply (e.g. model codes ODE-3-xxxxx-3xxx) may be operated from a single phase supply at up to 50% of maximum rated output current capacity.

In this case, the AC power supply should be connected to L1 (L) and L2 (N) power connection terminals only.

10.4. Additional Information for UL Compliance

Optidrive E3 is designed to meet the UL requirements. For an up to date list of UL compliant products, please refer to UL listing NMMS.E226333. In order to ensure full compliance, the following must be fully observed.

Input Power Supply Requirements				
Supply Voltage	200 – 240 RMS Volts for 230 Volt rated units, + / - 10% variation allowed. 240 Volt RMS Maximum.			
	380 – 480 Volts for 400 Volt rated units, + / - 10% variation allowed, Maximum 500 Volts RMS.			
Imbalance	Maximum 3% voltage variation between phase – phase voltages allowed.			
	All Optidrive E3 units have phase imbalance monitoring. A phase imbalance of > 3% will result in the drive tripping. For input supplies which have supply imbalance greater than 3% (typically the Indian sub-continent & parts of Asia Pacific including China) Invertek Drives recommends the installation of input line reactors.			
Frequency	50 – 60Hz + / - 5% Variation			
Short Circuit Capacity	Voltage Rating	Min kW (HP)	Max kW (HP)	Maximum supply short-circuit current
	115V	0.37 (0.5)	1.1 (1.5)	100kA rms (AC)
	230V	0.37 (0.5)	11 (15)	100kA rms (AC)
	400 / 460V	0.75 (1)	22 (30)	100kA rms (AC)
	All the drives in the above table are suitable for use on a circuit capable of delivering not more than the above specified maximum short-circuit Amperes symmetrical with the specified maximum supply voltage when protected by Class J fuses.			
Mechanical Installation Requirements				
All Optidrive E3 units are intended for installation within controlled environments which meet the condition limits shown in section 10.1. Environmental.				
The drive can be operated within an ambient temperature range as stated in section 10.1. Environmental.				
Electrical Installation Requirements				
Incoming power supply connection must be according to section 4.4. Incoming Power Connection.				
Suitable Power and motor cables should be selected according to the data shown in section 10.2. Rating Tables and the National Electrical Code or other applicable local codes.				
Motor Cable	75°C Copper must be used.			
Power cable connections and tightening torques are shown in section 3.3. Mechanical Dimensions – IP66 (Nema 4X) Enclosed Units.				
Integral Solid State short circuit protection does not provide branch circuit protection. Branch circuit protection must be provided in accordance with the national electrical code and any additional local codes. Ratings are shown in section 10.2. Rating Tables.				
Transient surge suppression must be installed on the line side of this equipment and shall be rated 480Volt (phase to ground), 480 Volt (phase to phase), suitable for over voltage category iii and shall provide protection for a rated impulse withstand voltage peak of 4kV.				
UL Listed ring terminals / lugs must be used for all bus bar and grounding connections.				
General Requirements				
Optidrive E3 provides motor overload protection in accordance with the National Electrical Code (US).				
<ul style="list-style-type: none"> Where a motor thermistor is not fitted, or not utilised, Thermal Overload Memory Retention must be enabled by setting P-50 = 1. Where a motor thermistor is fitted and connected to the drive, connection must be carried out according to the information shown in section 4.11.2. Motor Thermistor Connection. 				

10.5. EMC Filter Disconnect

Drives with an EMC filter have an inherently higher leakage current to Ground (Earth). For applications where tripping occurs the EMC filter can be disconnected by completely removing the EMC screw on the side of the product.

Remove the screw as indicated right.

The Optidrive product range has input supply voltage surge suppression components fitted to protect the drive from line voltage transients, typically originating from lightning strikes or switching of high power equipment on the same supply.

No flash test should be performed on the drive.

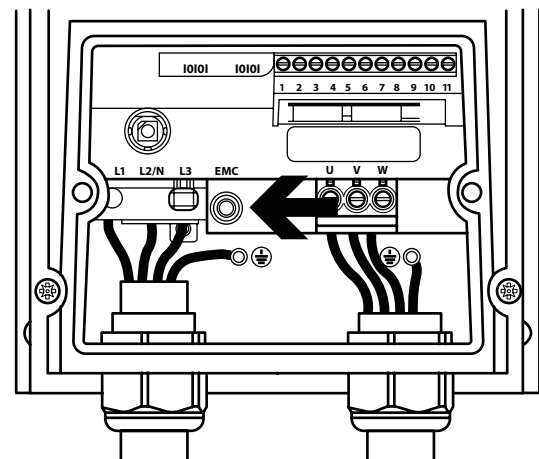

11. Troubleshooting

11.1. Fault Code Messages

Fault Code	No.	Description	Suggested Remedy
no-FLt	00	No Fault	Not required.
OI-b	01	Brake channel over current	Check external brake resistor condition and connection wiring.
OL-br	02	Brake resistor overload	The drive has tripped to prevent damage to the brake resistor.
O-I	03	Output Over Current	Instantaneous Over current on the drive output. Excess load or shock load on the motor. NOTE Following a trip, the drive cannot be immediately reset. A delay time is inbuilt, which allows the power components of the drive time to recover to avoid damage.
I-ot-trP	04	Motor Thermal Overload (I2t)	The drive has tripped after delivering >100% of value in P-08 for a period of time to prevent damage to the motor.
O-uolt	06	Over voltage on DC bus	Check the supply voltage is within the allowed tolerance for the drive. If the fault occurs on deceleration or stopping, increase the deceleration time in P-04 or install a suitable brake resistor and activate the dynamic braking function with P-34.
U-uolt	07	Under voltage on DC bus	The incoming supply voltage is too low. This trip occurs routinely when power is removed from the drive. If it occurs during running, check the incoming power supply voltage and all components in the power feed line to the drive.
O-t	08	Heatsink over temperature	The drive is too hot. Check the ambient temperature around the drive is within the drive specification. Ensure sufficient cooling air is free to circulate around the drive.
U-t	09	Under temperature	The drive temperature is below the minimum limit and must be increased to operate the drive.
P-dEF	10	Factory Default parameters loaded	
E-tr iP	11	External trip	E-trip requested on digital input 3. Normally closed contact has opened. If motor thermistor is connected check if the motor is too hot.
SC-ObS	12	Optibus comms loss	Check communication link between drive and external devices. Make sure each drive in the network has its unique address.
FLt-dc	13	DC bus ripple too high	Check incoming supply phases are all present and balanced.
P-LOSS	14	Input phase loss trip	Check incoming power supply phases are present and balanced.
h O-I	15	Output Over Current	Check for short circuits on the motor and connection cable. NOTE Following a trip, the drive cannot be immediately reset. A delay time is inbuilt, which allows the power components of the drive time to recover to avoid damage.
th-FLt	16	Faulty thermistor on heatsink	
dRtA-F	17	Internal memory fault (IO)	Press the stop key. If the fault persists, consult you supplier.
4-20 F	18	4-20mA Signal Lost	Check the analog input connection(s).
dRtA-E	19	Internal memory fault (DSP)	Press the stop key. If the fault persists, consult you supplier.
F-Ptc	21	Motor PTC thermistor trip	Connected motor thermistor over temperature, check wiring connections and motor.
FRn-F	22	Cooling Fan Fault (IP66 only)	Check / replace the cooling fan.
O-hEAt	23	Drive internal temperature too high	Drive ambient temperature too high, check adequate cooling air is provided.
OUE-F	26	Output Fault	Indicates a fault on the output of the drive, such as one phase missing, motor phase currents not balanced. Check the motor and connections.
AtF-Q2	41	Autotune Fault	The motor parameters measured through the autotune are not correct. Check the motor cable and connections for continuity. Check all three phases of the motor are present and balanced.
SC-FQ1	50	Modbus comms loss fault	Check the incoming Modbus RTU connection cable. Check that at least one register is being polled cyclically within the timeout limit set in P-36 Index 3.
SC-FQ2	51	CAN comms loss trip	Check the incoming CAN connection cable. Check that cyclic communications take place within the timeout limit set in P-36 Index 3.

NOTE Following an over current or overload trip (3, 4, 5, 15), the drive may not be reset until the reset time delay has elapsed to prevent damage to the drive.

11.2 Resetting a Fault

When the drive trips, and a fault message is displayed, it can be reset in one of the following ways:

- Completely remove the incoming power supply, and allow the power to power off completely. Re-apply the power.
- Remove and reapply the enable input.
- Press the stop / Reset button.
- If Modbus or CAN are in use, set the reset bit in the control word from 0 to 1.

In the event of O-I, hO-I or I.t-trp faults, in order to prevent damage that may occur through repeatedly enabling the drive into a fault condition, these trips cannot be reset immediately. A delay time according to the following table must be allowed before reset is possible.

First Trip	2 seconds delay before reset is possible
Second Trip	4 seconds delay before reset is possible
Third Trip	8 seconds delay before reset is possible
Fourth Trip	16 seconds delay before reset is possible
Fifth Trip	32 seconds delay before reset is possible
Subsequent Trips	64 seconds delay before reset is possible

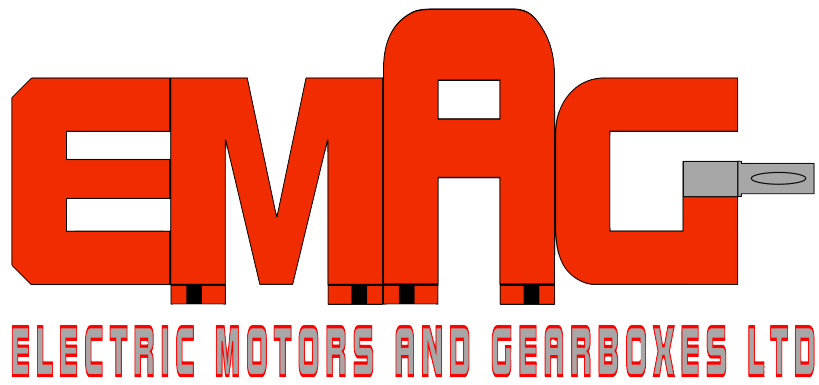

**Units 14-16 G5 Industrial Park
Ettingshall
West Midlands
WV4 6FG**

**01902 601403
sales@emag-ltd.co.uk**